

# Leica Rugby 870/880 User Manual



Version 1.0  
English

- when it has to be **right**

**Leica**  
Geosystems

# Introduction

## Purchase

Congratulations on the purchase of a Leica Rotating Laser product.



This manual contains important safety directions as well as instructions for setting up the product and operating it. Refer to "1 Safety Directions" for further information. Read carefully through the User Manual before you switch on the product.

## Product identification

The type and serial number of your product are indicated on the type plate. Always refer to this information when you need to contact your agency or Leica Geosystems authorised service workshop.

## Validity of this manual

This manual applies to the Rugby 870/880 lasers. Differences between the models are marked and described.

## Available documentation

Name	Description/Format		
Rugby 870/880 Quick Guide	Provides an overview of the product. Intended as a quick reference guide.	✓	✓
Rugby 870/880 User Manual	All instructions required in order to operate the product to a basic level are contained in the User Manual. Provides an overview of the product together with technical data and safety directions.	-	✓

**Refer to the following resources for all Rugby 870/880 documentation/software:**

- the Leica Rugby CD
- <https://myworld.leica-geosystems.com>

myWorld@Leica Geosystems (<https://myworld.leica-geosystems.com>) offers a wide range of services, information and training material.

With direct access to myWorld, you are able to access all relevant services whenever it is convenient for you, 24 hours a day, 7 days per week. This increases your efficiency and keeps you and your equipment instantly updated with the latest information from Leica Geosystems.

Service	Description
myProducts	Add all Leica Geosystems products that you and your company own. View detailed information on your products, buy additional options or Customer Care Packages (CCPs), update your products with the latest software and keep up-to-date with the latest documentation.
myService	View the service history of your products in Leica Geosystems Service Centres and detailed information on the services performed on your products. For your products that are currently in Leica Geosystems Service Centres view the current service status and the expected end date of service.
mySupport	Create new support requests for your products that will be answered by your local Leica Geosystems Support Team. View the complete history of your Support and view detailed information on each request in case you want to refer to previous support requests.
myTraining	Enhance your product knowledge with the Leica Geosystems Campus - Information, Knowledge, Training. Study the latest online training material or download training material on your products. Keep up-to-date with the latest News on your products and register for Seminars or Courses in your country.
myTrustedServices	Offers increased productivity while at the same time providing maximum security. <ul style="list-style-type: none"> <li>• myExchange With myExchange you can exchange any files/objects from your computer to any of your Leica Exchange Contacts.</li> <li>• mySecurity If your instrument is ever stolen, a locking mechanism is available to ensure that the instrument is disabled and can no longer be used.</li> </ul>

# Table of Contents

In this manual	Chapter	Page
<b>1</b>	<b>Safety Directions</b>	<b>6</b>
1.1	General	6
1.2	Definition of Use	7
1.3	Limits of Use	7
1.4	Responsibilities	7
1.5	Hazards of Use	8
1.6	Laser Classification	10
	1.6.1 General	10
	1.6.2 Rugby 870/880	10
1.7	Electromagnetic Compatibility EMC	11
1.8	FCC Statement, Applicable in U.S.	12
<b>2</b>	<b>Description of the System</b>	<b>14</b>
2.1	System Components	14
2.2	Rugby Laser Components	15
2.3	Case Components	15
2.4	Setup	16
<b>3</b>	<b>Operation</b>	<b>17</b>
3.1	Control Panel	17
3.2	Turning the Rugby on and off	17
3.3	The LCD Display	18
3.4	Grade Entry	19
3.5	Axis Identification	21
3.6	Conversion of Slope Into Percent of Grade	21
3.7	Alignment of the Axes	22
3.8	Precise Alignment of the Axes	22
3.9	Laydown Operation (Rugby 880 Only)	23
<b>4</b>	<b>RC800 Remote Control</b>	<b>24</b>
4.1	Description of the Remote Control	24
4.2	Pairing the Rugby 870/880 with the RC800 Remote Control	25
4.3	Connecting Screens for the Remote Control	26
<b>5</b>	<b>Receiver</b>	<b>27</b>
5.1	The Rod Eye Receivers	27
	5.1.1 Rod Eye 140, Classic Receiver	27
	5.1.2 Rod Eye 160, Digital Receiver	27
	5.1.3 Rod Eye 180, Digital RF Receiver	28
5.2	Using the Rod Eye 180 Receiver with the Rugby	28
5.3	Pairing the Rod Eye 180 with the Rugby 870/880	29
<b>6</b>	<b>Rugby 870/880 Menu</b>	<b>30</b>
6.1	Access and Navigation	30
6.2	Menu Set 1	31
6.3	Menu Set 2	34
6.4	Menu Set 3	36
<b>7</b>	<b>RC800 Menu</b>	<b>41</b>

<b>8</b>	<b>Applications</b>	<b>42</b>
8.1	Setting Forms	42
8.2	Checking Grades	43
8.3	Entering Grades	44
8.4	Smart Targeting (Grade Matching)	45
8.5	Smart Target Lock (Grade Matching and Monitoring)	46
8.6	Automatic Axis Alignment	47
8.7	Axis Alignment plus Smart Target Lock (Axis Alignment and Monitoring)	49
8.8	Dual Receiver Setups	49
<b>9</b>	<b>Batteries</b>	<b>50</b>
9.1	Operating Principles	50
9.2	Battery for Rugby	51
<b>10</b>	<b>Accuracy Adjustment</b>	<b>54</b>
10.1	Checking the Level Accuracy	54
10.2	Adjusting the Level Accuracy	55
10.3	Adjusting the Vertical Accuracy	57
<b>11</b>	<b>Semi-Automatic Calibration</b>	<b>58</b>
<b>12</b>	<b>Troubleshooting</b>	<b>61</b>
<b>13</b>	<b>Care and Transport</b>	<b>64</b>
13.1	Transport	64
13.2	Storage	64
13.3	Cleaning and Drying	65
<b>14</b>	<b>Technical Data</b>	<b>66</b>
14.1	Conformity to National Regulations	66
14.2	General Technical Data of the Laser	66
14.2.1	RC800 Remote Control	68
<b>15</b>	<b>Lifetime Manufacturer's Warranty</b>	<b>68</b>
<b>16</b>	<b>Accessories</b>	<b>69</b>
	<b>Index</b>	<b>70</b>

# 1 Safety Directions

## 1.1 General

### Description

The following directions enable the person responsible for the product, and the person who actually uses the equipment, to anticipate and avoid operational hazards.

The person responsible for the product must ensure that all users understand these directions and adhere to them.

### About Warning Messages





Warning messages are an essential part of the safety concept of the instrument. They appear wherever hazards or hazardous situations can occur.

#### Warning messages...

- make the user alert about direct and indirect hazards concerning the use of the product.
- contain general rules of behaviour.

For the users' safety, all safety instructions and safety messages shall be strictly observed and followed! Therefore, the manual must always be available to all persons performing any tasks described herein.

**DANGER, WARNING, CAUTION** and **NOTICE** are standardized signal words for identifying levels of hazards and risks related to personal injury and property damage. For your safety it is important to read and fully understand the table below with the different signal words and their definitions! Supplementary safety information symbols may be placed within a warning message as well as supplementary text.

Type	Description
 <b>DANGER</b>	Indicates an imminently hazardous situation which, if not avoided, will result in death or serious injury.
 <b>WARNING</b>	Indicates a potentially hazardous situation or an unintended use which, if not avoided, could result in death or serious injury.
 <b>CAUTION</b>	Indicates a potentially hazardous situation or an unintended use which, if not avoided, may result in minor or moderate injury.
<b>NOTICE</b>	Indicates a potentially hazardous situation or an unintended use which, if not avoided, may result in appreciable material, financial and environmental damage.
	Important paragraphs which must be adhered to in practice as they enable the product to be used in a technically correct and efficient manner.

## 1.2

### Definition of Use

---

#### Intended use

- The product casts a horizontal laser plane or a laser beam for the purpose of alignment.
  - The laser beam can be detected by means of a laser detector.
  - Remote control of product.
  - Data communication with external appliances.
- 

#### Reasonably foreseeable misuse

- Use of the product without instruction.
  - Use outside of the intended use and limits.
  - Disabling safety systems.
  - Removal of hazard notices.
  - Opening the product using tools, for example screwdriver, unless this is permitted for certain functions.
  - Modification or conversion of the product.
  - Use after misappropriation.
  - Use of products with recognisable damages or defects.
  - Use with accessories from other manufacturers without the prior explicit approval of Leica Geosystems.
  - Inadequate safeguards at the working site.
  - Deliberate dazzling of third parties.
  - Controlling of machines, moving objects or similar monitoring application without additional control- and safety installations.
- 

## 1.3

### Limits of Use

---

#### Environment

Suitable for use in an atmosphere appropriate for permanent human habitation: not suitable for use in aggressive or explosive environments.

---



**DANGER**

Local safety authorities and safety experts must be contacted before working in hazardous areas, or close to electrical installations or similar situations by the person in charge of the product.

---

## 1.4

### Responsibilities

---

#### Manufacturer of the product

Leica Geosystems AG, CH-9435 Heerbrugg, hereinafter referred to as Leica Geosystems, is responsible for supplying the product, including the user manual and original accessories, in a safe condition.

---

#### Person responsible for the product

The person responsible for the product has the following duties:

- To understand the safety instructions on the product and the instructions in the user manual.
  - To ensure that it is used in accordance with the instructions.
  - To be familiar with local regulations relating to safety and accident prevention.
  - To inform Leica Geosystems immediately if the product and the application becomes unsafe.
  - To ensure that the national laws, regulations and conditions for the operation of e.g. radio transmitters or lasers are respected.
-

## 1.5

## Hazards of Use



### CAUTION

Watch out for erroneous measurement results if the product has been dropped or has been misused, modified, stored for long periods or transported.

#### **Precautions:**

Periodically carry out test measurements and perform the field adjustments indicated in the user manual, particularly after the product has been subjected to abnormal use and before and after important measurements.



### DANGER

Because of the risk of electrocution, it is dangerous to use poles and extensions in the vicinity of electrical installations such as power cables or electrical railways.

#### **Precautions:**

Keep at a safe distance from electrical installations. If it is essential to work in this environment, first contact the safety authorities responsible for the electrical installations and follow their instructions.



### NOTICE

With the remote control of products, it is possible that extraneous targets will be picked out and measured.

#### **Precautions:**

When measuring in remote control mode, always check your results for plausibility.



### WARNING

If the product is used with accessories, for example masts, staffs, poles, you may increase the risk of being struck by lightning.

#### **Precautions:**

Do not use the product in a thunderstorm.



### WARNING

Inadequate securing of the working site can lead to dangerous situations, for example in traffic, on building sites, and at industrial installations.

#### **Precautions:**

Always ensure that the working site is adequately secured. Adhere to the regulations governing safety and accident prevention and road traffic.



### CAUTION

If the accessories used with the product are not properly secured and the product is subjected to mechanical shock, for example blows or falling, the product may be damaged or people can sustain injury.

#### **Precautions:**

When setting-up the product, make sure that the accessories are correctly adapted, fitted, secured, and locked in position.

Avoid subjecting the product to mechanical stress.



### WARNING

During the transport, shipping or disposal of batteries it is possible for inappropriate mechanical influences to constitute a fire hazard.

#### **Precautions:**

Before shipping the product or disposing of it, discharge the batteries by running the product until they are flat.

When transporting or shipping batteries, the person in charge of the product must ensure that the applicable national and international rules and regulations are observed. Before transportation or shipping contact your local passenger or freight transport company.



**WARNING**

During dynamic applications, for example stakeout procedures there is a danger of accidents occurring if the user does not pay attention to the environmental conditions around, for example obstacles, excavations or traffic.

**Precautions:**

The person responsible for the product must make all users fully aware of the existing dangers.

---

**WARNING**

If you open the product, either of the following actions may cause you to receive an electric shock.

- Touching live components
- Using the product after incorrect attempts were made to carry out repairs

**Precautions:**

Do not open the product. Only Leica Geosystems authorised service workshops are entitled to repair these products.

---

**WARNING**

If the product is improperly disposed of, the following can happen:

- If polymer parts are burnt, poisonous gases are produced which may impair health.
- If batteries are damaged or are heated strongly, they can explode and cause poisoning, burning, corrosion or environmental contamination.
- By disposing of the product irresponsibly you may enable unauthorised persons to use it in contravention of the regulations, exposing themselves and third parties to the risk of severe injury and rendering the environment liable to contamination.

**Precautions:**

The product must not be disposed with household waste.

Dispose of the product appropriately in accordance with the national regulations in force in your country.

Always prevent access to the product by unauthorised personnel.

Product-specific treatment and waste management information can be downloaded from the Leica Geosystems home page at <http://www.leica-geosystems.com/treatment> or received from your Leica Geosystems dealer.

---

**WARNING**

Only Leica Geosystems authorised service workshops are entitled to repair these products.

---

**WARNING**

High mechanical stress, high ambient temperatures or immersion into fluids can cause leakage, fire or explosions of the batteries.

**Precautions:**

Protect the batteries from mechanical influences and high ambient temperatures. Do not drop or immerse batteries into fluids.

---

**WARNING**

If battery terminals are short circuited e.g. by coming in contact with jewellery, keys, metalized paper or other metals, the battery can overheat and cause injury or fire, for example by storing or transporting in pockets.

**Precautions:**

Make sure that the battery terminals do not come into contact with metallic objects.

---

## 1.6



## Laser Classification

### 1.6.1

### General

#### General

The following chapters provide instructions and training information about laser safety according to international standard IEC 60825-1 (2014-05) and technical report IEC TR 60825-14 (2004-02). The information enables the person responsible for the product and the person who actually uses the equipment, to anticipate and avoid operational hazards.

-  According to IEC TR 60825-14 (2004-02), products classified as laser class 1, class 2 and class 3R do not require:
  - laser safety officer involvement,
  - protective clothes and eyewear,
  - special warning signs in the laser working areaif used and operated as defined in this User Manual due to the low eye hazard level.
-  National laws and local regulations could impose more stringent instructions for the safe use of lasers than IEC 60825-1 (2014-05) and IEC TR 60825-14 (2004-02).

### 1.6.2

### Rugby 870/880

#### General

The rotating laser built into the product produces a visible laser beam which emerges from the rotating head.

The product described in this section is classified as laser class 1 in accordance with:

- IEC 60825-1 (2014-05): "Safety of laser products"

These products are safe for momentary exposures but can be hazardous for deliberate staring into the beam. The beam may cause dazzle, flash-blindness and after-images, particularly under low ambient light conditions.

#### Rugby 870:

Description	Value
Maximum peak radiant power	0.65 mW / 2.2 mW
Pulse duration (effective)	500 ms / 2.9 ms, 1.4 ms
Pulse repetition frequency	1 Hz / 5 Hz, 10 Hz
Beam divergence	0.2 mrad
Wavelength	635 nm

#### Rugby 880:

Description	Value
Maximum peak radiant power	0.65 mW / 2.2 mW
Pulse duration (effective)	500 ms / 2.9 ms, 1.4 ms
Pulse repetition frequency	1 Hz / 5 Hz, 10 Hz
Beam divergence	0.2 mrad
Wavelength	635 nm

## Labelling

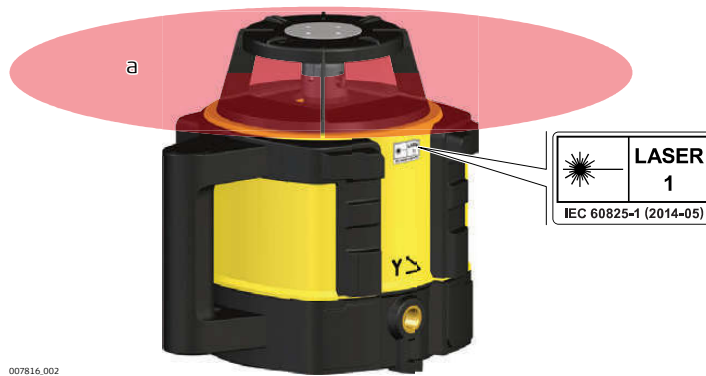

a) Laser beam

## 1.7

### Electromagnetic Compatibility EMC

#### Description

The term Electromagnetic Compatibility is taken to mean the capability of the product to function smoothly in an environment where electromagnetic radiation and electrostatic discharges are present, and without causing electromagnetic disturbances to other equipment.



#### WARNING

Electromagnetic radiation can cause disturbances in other equipment.

Although the product meets the strict regulations and standards which are in force in this respect, Leica Geosystems cannot completely exclude the possibility that other equipment may be disturbed.



#### CAUTION

There is a risk that disturbances may be caused in other equipment if the product is used with accessories from other manufacturers, for example field computers, personal computers or other electronic equipment, non-standard cables or external batteries.

#### Precautions:

Use only the equipment and accessories recommended by Leica Geosystems. When combined with the product, they meet the strict requirements stipulated by the guidelines and standards. When using computers or other electronic equipment, pay attention to the information about electromagnetic compatibility provided by the manufacturer.



#### CAUTION

Disturbances caused by electromagnetic radiation can result in erroneous measurements.

Although the product meets the strict regulations and standards which are in force in this respect, Leica Geosystems cannot completely exclude the possibility that the product may be disturbed by intense electromagnetic radiation, for example, near radio transmitters, two-way radios or diesel generators.

#### Precautions:

Check the plausibility of results obtained under these conditions.



#### CAUTION

If the product is operated with connecting cables attached at only one of their two ends, for example external supply cables, interface cables, the permitted level of electromagnetic radiation may be exceeded and the correct functioning of other products may be impaired.

#### Precautions:

While the product is in use, connecting cables, for example product to external battery, product to computer, must be connected at both ends.

## Radios or digital cellular phones



### WARNING

Use of product with radio or digital cellular phone devices:

Electromagnetic fields can cause disturbances in other equipment, in installations, in medical devices, for example pacemakers or hearing aids and in aircraft. It can also affect humans and animals.

#### Precautions:

Although the product meets the strict regulations and standards which are in force in this respect, Leica Geosystems cannot completely exclude the possibility that other equipment can be disturbed or that humans or animals can be affected.

- Do not operate the product with radio or digital cellular phone devices in the vicinity of filling stations or chemical installations, or in other areas where an explosion hazard exists.
- Do not operate the product with radio or digital cellular phone devices near to medical equipment.
- Do not operate the product with radio or digital cellular phone devices in aircraft.

## 1.8

### FCC Statement, Applicable in U.S.



The greyed paragraph below is only applicable for products without radio.



### WARNING

This equipment has been tested and found to comply with the limits for a Class B digital device, pursuant to part 15 of the FCC rules.

These limits are designed to provide reasonable protection against harmful interference in a residential installation.

This equipment generates, uses and can radiate radio frequency energy and, if not installed and used in accordance with the instructions, may cause harmful interference to radio communications. However, there is no guarantee that interference will not occur in a particular installation.

If this equipment does cause harmful interference to radio or television reception, which can be determined by turning the equipment off and on, the user is encouraged to try to correct the interference by one or more of the following measures:

- Reorient or relocate the receiving antenna.
- Increase the separation between the equipment and the receiver.
- Connect the equipment into an outlet on a circuit different from that to which the receiver is connected.
- Consult the dealer or an experienced radio/TV technician for help.



### WARNING

Changes or modifications not expressly approved by Leica Geosystems for compliance could void the user's authority to operate the equipment.

## Labelling Rugby 870/880



## Labelling Rod Eye

### Rod Eye 140:

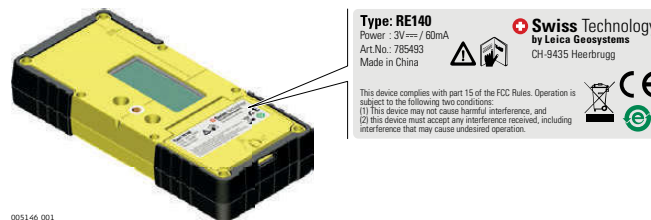

## Labelling Rod Eye

### Rod Eye 160:

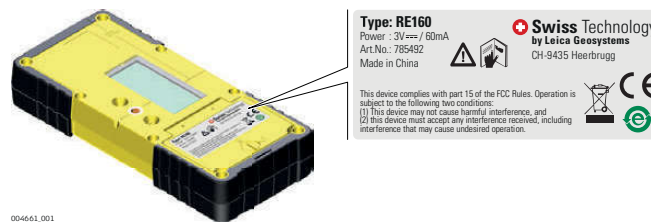

## Labelling Rod Eye

### Rod Eye 180

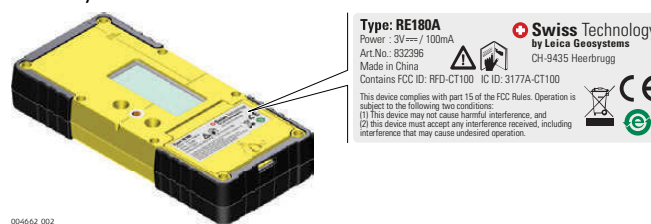

## Labelling RC800

### RC800

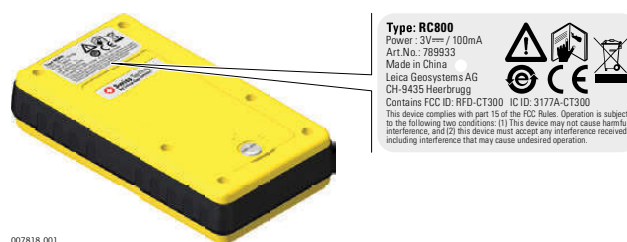

## 2 Description of the System

### 2.1 System Components

**General description** The Rugby 870 and the Rugby 880 are laser tools for general construction, levelling and slope applications such as

- Setting forms,
- Levelling to grade,
- Controlling depths for excavations.

If set up within the self-levelling range, the Rugby automatically levels to create an accurate horizontal or vertical (Rugby 880 only) or sloped plane of laser light. Once the Rugby has levelled, the head starts rotating and the Rugby is ready for use. 30 seconds after the Rugby has completed the levelling, the H.I.Alert system becomes active and protects the Rugby against changes in elevation caused by movement of the tripod to ensure accurate work.

**Area of application** **Single grade**

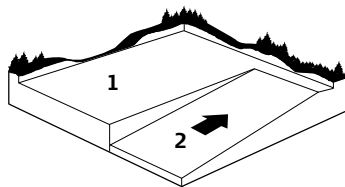

The Rugby 870 is a single grade laser; it produces an accurate plane of laser light for applications which require level (1) or single slope (2).

**Dual grade**

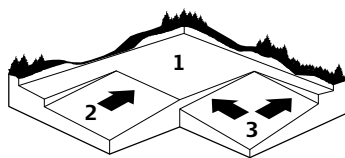

The Rugby 880 is a dual grade laser; it produces an accurate plane of laser light for applications which require level (1), single slope (2) or dual slope (3).

**Available system components**



The delivered components depend on the package ordered.

## 2.2

## Rugby Laser Components

### Rugby laser components



007820.001

- a) Plate for optional scope
- b) Carry Handle
- c) LCD Display
- d) Control Panel
- e) Battery compartment

## 2.3

## Case Components

### Case components



007821.001

- a) Rugby laser
- b) Rod eye receiver mounted on the bracket
- c) Li-Ion battery pack or Alkaline battery pack
- d) RC800 remote control
- e) 2x AA-cell battery
- f) User Manual/CD
- g) Second receiver (can be purchased separately)
- h) 4 x D-cell battery (for alkaline versions only)
- i) Charger (for Li-Ion versions only)
- j) Optional scope assembly

## 2.4

## Setup

### Location

- Keep the location clear of possible obstructions that could block or reflect the laser beam.
- Place the Rugby on a stable ground. Ground vibration and extremely windy conditions can affect the operation of the Rugby.
- When working in a very dusty environment place the Rugby up-wind so the dirt is blown away from the laser.

### Setting up on a tripod



Step	Description
1.	Set up the tripod.
2.	Place the Rugby on the tripod.
3.	Tighten the screw on the underside of the tripod to secure the Rugby on the tripod.

- Attach the Rugby securely to a tripod or laser trailer, or mount on a stable level surface.
- Always check the tripod or laser trailer before attaching the Rugby. Make sure all screws, bolts and nuts are tight.
- If a tripod has chains, they should be slightly loose to allow for thermal expansion during the day.
- Secure the tripod on extremely windy days.



### 3

## Operation

### 3.1

#### Control Panel

##### Overview

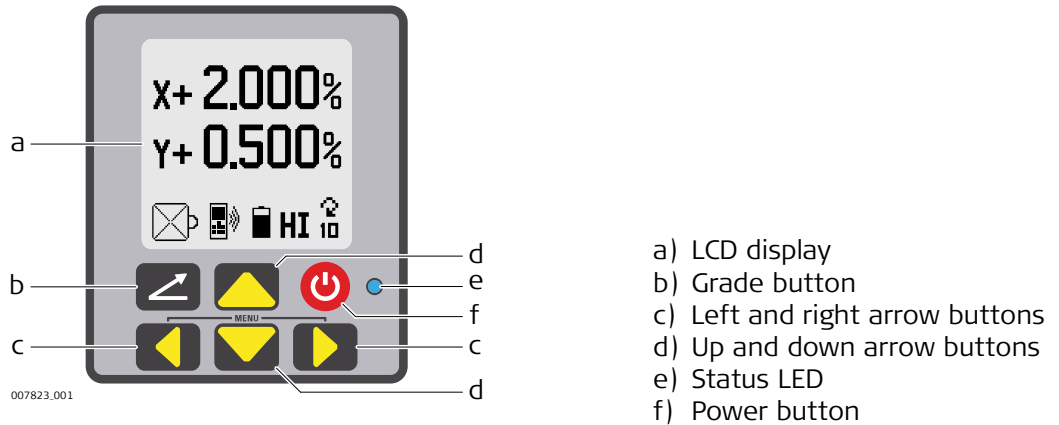

##### Control panel - functions

LCD display	Displays all required user information.
Grade button	Press to start grade entry mode.
Left and right arrow buttons	Press to display and move the cursor for grade entry. Press both simultaneously to enter the Rugby menu.
Up and down arrow buttons	Press to change the grade displayed. Press both simultaneously to reset the grade value to zero.
Power button	Press to turn on or off the Rugby.
Status LED	Indicates the level status of the Rugby.

### 3.2

#### Turning the Rugby on and off

##### Turning on and off

Press the Power Button to turn on or off the Rugby.

##### After turning on:

- The LCD display turns on and displays the current status of the Rugby.
- If set up within the +/-6° self-levelling range (horizontal or vertical), the Rugby automatically levels to create an accurate horizontal plane of laser light.
- Once levelled, the head starts rotating and Rugby is ready for use.
- If activated, the H.I.Alert system becomes active 30 seconds after completing the levelling. The H.I.Alert system protects the laser against changes in elevation caused by movement or settling of the tripod.
- The self-levelling system and the H.I.Alert function continue to monitor the position of the laser beam to ensure consistent and accurate work.

### 3.3

## The LCD Display

### Main Display

The LCD display shows all the information that is required to operate the Rugby.

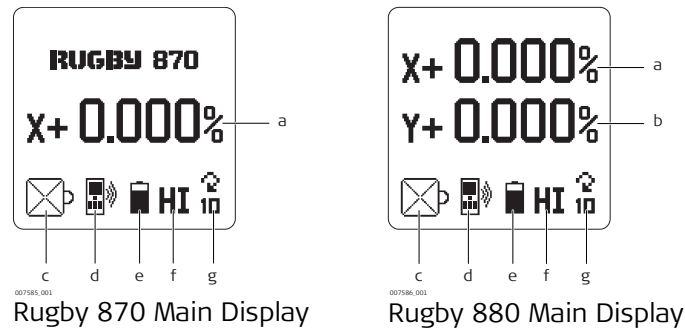

- a) X-axis Grade Value
- b) Y-axis Grade Value (Rugby 880 only)
- c) Beam Masking
- d) Radio Indication
- e) Battery Level Indication
- f) H.I. Indication
- g) Head Speed

### Start-up Screens

When you turn on the Rugby, the LCD displays the Leica welcome screen, the customer name screen and the information screen.



#### Leica welcome screen



#### Customer name screen:

This screen only appears if you enabled it in the menu. Refer to 6.4" Customer Name Settings".

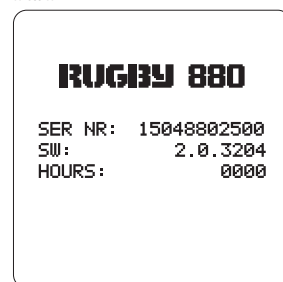



#### Information screen:

This screen displays the unit model number, serial number, software revision level and the hours of use.

### 3.4

## Grade Entry

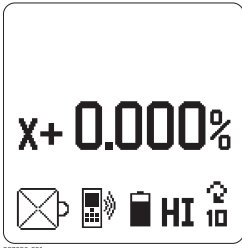
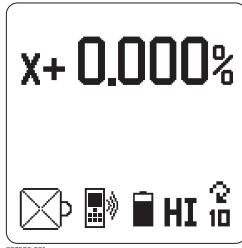
### Direct Grade Entry

Step	Description
1.	<p>Rugby 870/880: To start grade entry mode press the Grade Button once.   To restore the last set grade(s), press and hold the Grade Button for 1.5 seconds.</p>
	<p><i>The X-axis grade value is displayed.</i></p> <div style="display: flex; justify-content: space-around; align-items: center;"> <div style="text-align: center;">  <p>X-Axis grade entry (Rugby 870)</p> </div> <div style="text-align: center;">  <p>X-Axis grade entry (Rugby 880)</p> </div> </div>
2.	To change the grade value press the Up or Down Arrow Buttons.
3.	<p><b>Rugby 880 only:</b> To enter grade on the Y-axis press the Grade Button a second time. <i>Only the Y-axis grade value is displayed.</i></p> <div style="text-align: center;">  <p>Y-Axis grade entry (Rugby 880)</p> </div>
4.	To change the grade value press the Up or Down Arrow Buttons.
5.	<p>To exit grade entry mode, press the Grade Button until the main display is shown. OR: Wait for 8 seconds. The Rugby automatically returns to the main display.</p>

**Grade Entry by Digit**

While in grade entry mode, you can easily change the plus/minus sign or individual digits.

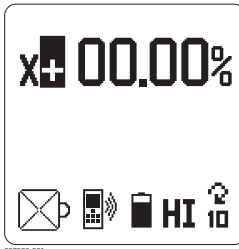
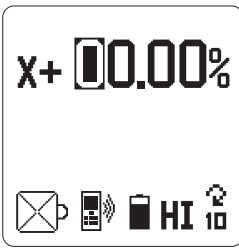
Step	Description
	Press the Grade Button to enter the grade entry mode.
1.	Press the Left or Right Arrow Buttons to create a cursor. The cursor always appears on the plus/minus sign. 
2.	Press the Up or Down Arrow Buttons to change the plus/minus sign.
3.	Press the Left or Right Arrow Buttons to move the cursor. 
4.	Press the Up or Down Arrow Buttons to change a digit.
5.	To exit grade entry mode, press the Grade Button until the main display is shown. OR: Wait for 8 seconds. The Rugby automatically returns to the main display.

**Reset Grade Value to Zero**

While in grade entry mode, you can quickly change the grade value back to zero by pressing the Up and Down Arrow Buttons simultaneously.

**Grade Capability (Rugby 880 only)**

The Rugby 880 can have up to 10.00% grade simultaneously in both the X and Y axes or up to 15.00% grade in one axis. Entering grades above 10.00% in one axis is only possible if the cross axis grade is  $\pm 3\%$  or lower.

 If you try to enter grades greater than 3% or 10%, a notice appears on the screen when you press the button.

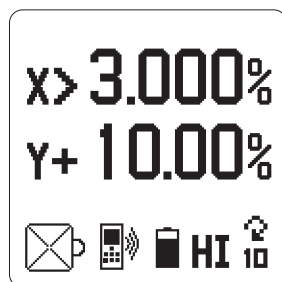

X > 3.000%

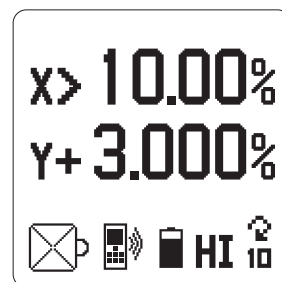

X > 10.00%

## Grade Swap

The grade in the X and Y axes can easily be swapped from positive to negative by changing the plus/minus sign in grade entry mode. Refer to **Grade Entry by Digit**. A typical application for this feature is road building. Example: The Rugby is set up on the crown of the road and one axis is aligned to the centreline. In order to make the cross axis grade fall to the right or left hand side, simply change the plus/minus sign on the display.

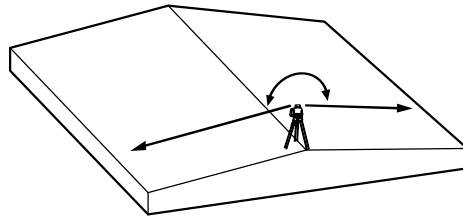

## 3.5

### Axis Identification

#### Axis identification

When entering grade, it is important to know the correct direction in which the grade is being entered. Refer to the following illustration to identify the correct directions of the axes.



007826\_001

## 3.6

### Conversion of Slope Into Percent of Grade

#### Conversion of slope

Slope: The change in elevation per unit of measure (foot, metre, etc.)

Percent of Grade: The change in elevation per 100 units of measure (feet, metre, etc.)

#### Calculating percent of grade from slope:

[Slope] x 100 = [Percent of Grade]

Example:

Slope	= 0.0059
Conversion	= 0.0059 x 100
Percent of Grade	= 0.590%

### 3.7

### Alignment of the Axes

#### Aligning X- and Y-axis

After the desired grade is correctly set in the display, align the X- and Y-axis to the jobsite.

☞ Ensure that the bubble of the circular level is positioned near the centre of the circle for maximum self-levelling capability.

☞ Ensure that the Rugby is properly positioned over a control point.

The direction of the X-Axis is seen from the front of the Rugby, sighting over the top of the Rugby.



Rotate the Rugby slightly until the alignment marks are aligned with your second control point.

Once the Rugby is aligned, you can start working.

### 3.8

### Precise Alignment of the Axes



#### Precisely aligning X- and Y-axis

Under most conditions, the raised alignment marks on the top of the Rugby are adequate for alignment of the axes. For a more precise alignment, you can use the following procedure.

Objective of a precise alignment:

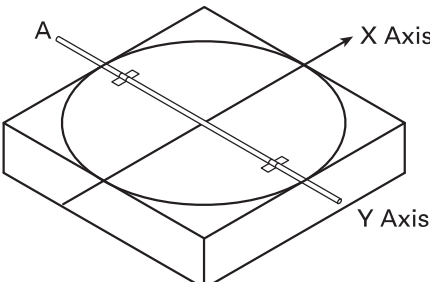
- To establish Point A on the Y-axis as a reference and take an elevation reading.
- To enter grade into the X-axis and then adjust the position of the laser until the original elevation at Point A is again found.

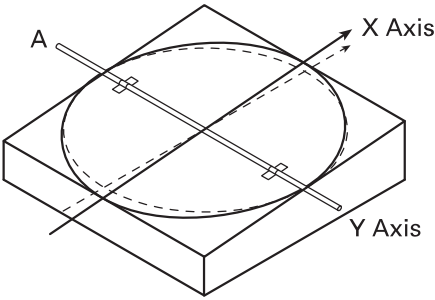
Step	Description
1.	With 0.000% grade in both axes, set up the Rugby directly over a grade stake and roughly align the Y-axis to a second grade stake (Point A).
2.	Take an elevation reading at Point A using a Rod Eye receiver and a survey rod. 
3.	Enter +5.000% grade into the X-axis. When grade is entered into the X-axis, the Y-axis acts like a hinge or fulcrum.

Step	Description
4.	<p>With +5.000% in the X-axis, take a second reading at Point A.</p> 
5.	<p>Alignment:</p> <ul style="list-style-type: none"> <li>• If the second reading is equal to the first reading, the X-axis is aligned correctly.</li> <li>• If the second reading is greater than the first reading, rotate the Rugby clockwise (to the right) until the two readings are equal.</li> <li>• If the second reading is less than the first reading, rotate the Rugby counter-clockwise (to the left) until the two readings are equal.</li> </ul>
	<p>Sighting Scope - An optional sighting scope is available for the Rugby 870/880 which improves the axis alignment for second day setups. It is recommended that you first perform the precise alignment procedure, and then adjust the scope to these axes.</p>
	<p>Automatic Axis Alignment - Automatic axis alignment is possible with the Rugby 870/880 using the Rod Eye 180 receiver. (Refer to "8.6 Automatic Axis Alignment")</p>

### 3.9

### Laydown Operation (Rugby 880 Only)

#### Vertical plane of laser light

You can use the Rugby 880 in laying down position to create a vertical plane for layout and alignment jobs.

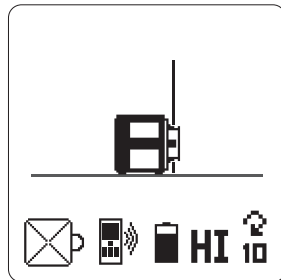

Rugby 880 Laying Down Screen

# 4

## RC800 Remote Control

### 4.1

### Description of the Remote Control

The RF Remote Control communicates with the Rugby via RF (radio frequency) and is used to control the same functions as on the laser.

#### RC800 Remote Control

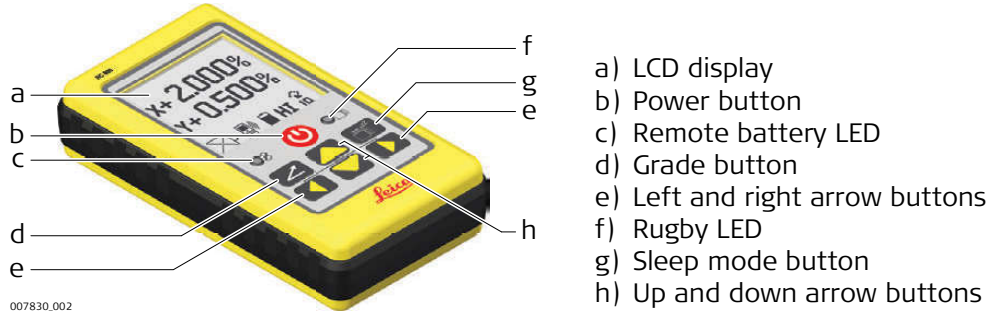

- a) LCD display
- b) Power button
- c) Remote battery LED
- d) Grade button
- e) Left and right arrow buttons
- f) Rugby LED
- g) Sleep mode button
- h) Up and down arrow buttons

#### Description of the Control Panel

LCD Display	Displays all required user information.
Power Button	Press to turn on or off the Remote Control.
Grade Button	Press to start grade entry mode.
Up and Down Arrow Buttons	Press to change the grade displayed. Press both simultaneously to reset the grade value to zero.
Left and Right Arrow Buttons	Press to display and move cursor for grade entry. Press both simultaneously to enter the Rugby menu. Press and hold simultaneously for 1.5 seconds to enter the Remote Control menu.
Sleep Mode Button	Press to put the Rugby in sleep mode. <ul style="list-style-type: none"> <li>• During Sleep Mode, all functions are disabled.</li> <li>• The LCD display indicates that the Rugby is in Sleep Mode.</li> <li>• The Rugby sleeps for 2 hours*, then shuts down automatically and must be turned on again at the laser.</li> <li>• When in Sleep Mode, pressing the sleep button wakes the Rugby and normal operation is resumed.</li> </ul>
Rugby LED	Indicates level status of the Rugby.
Remote Battery LED	Indicates when the batteries for the Remote Control should be replaced.

\* In the Remote Control menu, you can select the sleep time.



## Replacing the batteries

 The remote control is powered by 2x AA batteries. If the Remote Battery LED flashes, replace the batteries as shown in the picture.

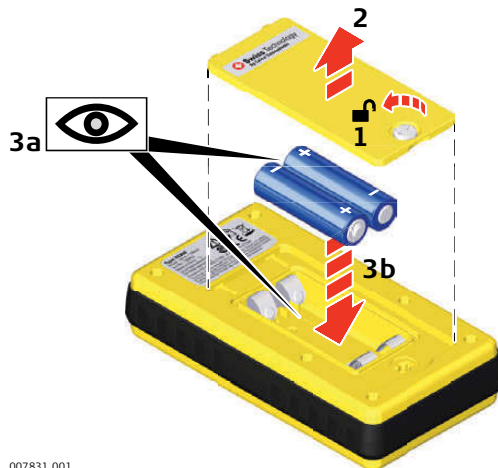



## 4.2

### Pairing the Rugby 870/880 with the RC800 Remote Control

**Pairing step-by-step** The Rugby 870/880 and the RC800 Remote Control include radio devices that allow you to activate the functions on the Rugby remotely up to 300 m (1000') from the Rugby.

Before using the RF features, the Rugby and the Remote Control must be paired together to be able to communicate with each other.

Step	Description
1.	Turn off both the Rugby 870/880 and the Remote Control.
2.	Press and hold the Power Button on the Rugby for 5 seconds to turn on the Rugby in pairing mode. The Rugby beeps five times slowly.
3.	Press and hold the Power Button on the Remote Control until pairing is confirmed.
	When the pairing is successful: Both the Rugby and the Remote Control beep quickly five times and the Status LED flashes green quickly (5 Hz). There is no confirmation on the LCD displays during this process.
	When the pairing is <b>not</b> successful: Both the Rugby and the Remote Control beep slowly three times and the Status LED flashes red (1 Hz).

## 4.3

## Connecting Screens for the Remote Control

---

### Information screens while connecting

There are three screens on the RC800 Remote Control which are displayed when connecting to the Rugby.

#### Wait Screen

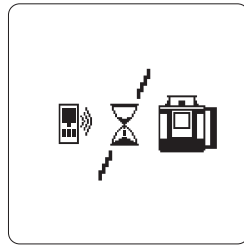

#### Connecting Screen

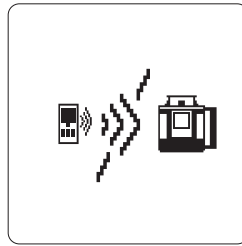

The "wait" and "connecting" screens are displayed when the Remote Control is first turned on and while connecting to the Rugby.

#### Lost Communication Screen

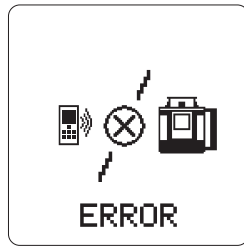

The "lost communication" screen is displayed when the Rugby and the Remote Control have lost their communication link.

☞ Ensure that you are within clear sight of the Rugby and that you have not exceeded the working range.

☞ The RC800 Remote Control has its own menu where you can change the display brightness, sleep mode hours and remote shut-off time. Refer to "7 RC800 Menu" for information on the Remote Control menu.

---

## 5 Receiver

### 5.1 The Rod Eye Receivers

**Rod Eye Receivers** The Rugby 870/880 are sold with the Leica Rod Eye Receivers. The Rod Eye 180 Digital Receiver enhances the performance of the Rugby 870/880 lasers with automatic slope catching, monitoring and axis alignment. The following information is appropriate only to the model you have purchased. Additional information on the Receivers can be found in the individual User Manuals also on this CD.

#### 5.1.1 Rod Eye 140, Classic Receiver

The Rod Eye 140 Classic Receiver provides you with basic position information by using an arrow display.

##### Instrument components

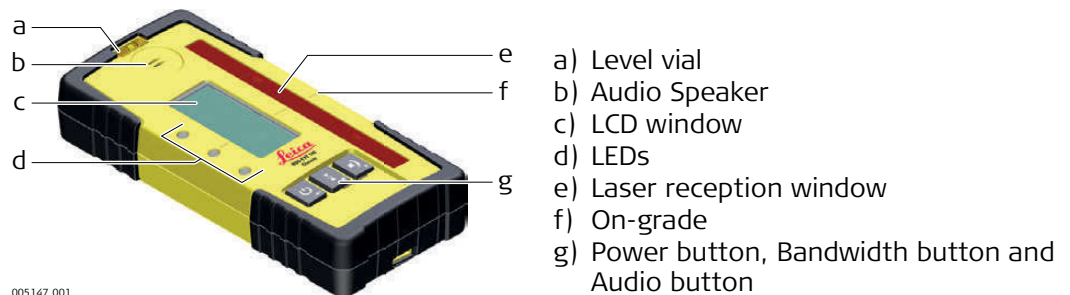

Button	Function
Power	Press once to turn on the Receiver.
Bandwidth	Press to change detection bandwidth.
Audio	Press to change the audio output.

#### 5.1.2 Rod Eye 160, Digital Receiver

The Rod Eye 160 Digital Receiver provides you with basic position information by using an arrow display plus digital readout.

##### Instrument components

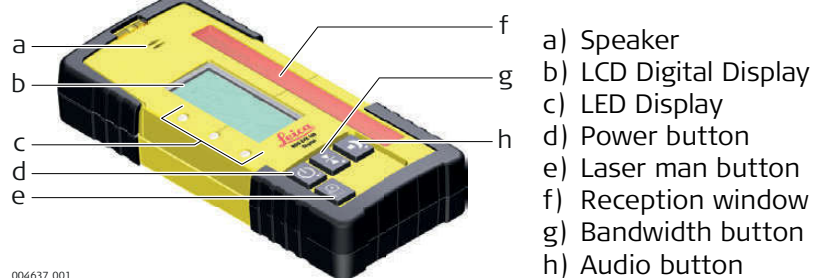

##### Description of the Buttons

Button	Function
Power	Press once to turn on the receiver.
	Press 1.5 seconds to turn off the receiver.
Laser man	Press to capture the digital reading.
Bandwidth	Press to change detection bandwidths.
Audio	Press to change the audio output.

### 5.1.3

## Rod Eye 180, Digital RF Receiver

The Rod Eye 180 RF Digital Receiver provides you with basic position information by using an arrow display, digital readout plus RF communication to the Rugby for special features.

### Instrument components



004638.001

- a) Speaker
- b) LCD Digital Display
- c) LED Display
- d) Power button
- e) Laser man button
- f) Reception window
- g) Bandwidth button
- h) Audio button
- i) X and Y buttons

### Description of the Buttons

Button	Function
Power	Press once to turn on the receiver.
	Press 1.5 seconds to turn off the receiver.
Laser man	Press to capture the digital reading.
	Press 1.5 seconds to start the Smart Target functions such as automatic slope catching on the X-axis in the upright mode and automatic vertical plane alignment in the laying down mode.
Bandwidth	Press to change detection bandwidths.
Audio	Press to change the audio output.
X and Y	Press to select alternate or second axis for slope catching and slope monitoring.

## 5.2

### Using the Rod Eye 180 Receiver with the Rugby

#### Special Functions when using Rod Eye 180 Receiver

The Rugby 870/880 can be used with almost any receiver.

However, when used with the Rod Eye 180 Digital RF Receiver, the following special functions are available:

- Smart Targeting - Allows you to match an existing grade. (Refer to "8.4 Smart Targeting (Grade Matching)")
- Smart Target Lock - Monitors the grade position to keep it on grade. (Refer to "8.5 Smart Target Lock (Grade Matching and Monitoring)")
- Automatic Axis Alignment - Electronically adjusts the axes of the Rugby to your grade stakes. (Refer to "8.6 Automatic Axis Alignment")
- Axis Alignment + Smart Target Lock - Monitors the grade position to keep it on grade. (Refer to "8.7 Axis Alignment plus Smart Target Lock (Axis Alignment and Monitoring)")
- Semi-automatic Calibration - Simply point one side of the Rugby towards the Rod Eye 180 Receiver, then follow the instructions on the screen displays. (Refer to "11 Semi-Automatic Calibration")



Before using the special functions, the Rugby and the Rod Eye 180 must be paired together to be able to communicate with each other. (Refer to "5.3 Pairing the Rod Eye 180 with the Rugby 870/880")

## 5.3

### Pairing the Rod Eye 180 with the Rugby 870/880

---

**Pairing step-by-step** The Rugby 870/880 and the Rod Eye 180 Receiver include radio devices that allow you to activate the functions on the Rugby remotely up to 100 m (300') from the Rugby. Before using the RF features, the Rugby and the Receiver must be paired together to be able to communicate with each other.

Step	Description
1.	Turn off the Rugby 870/880.
2.	Press and hold the Power Button on the Rugby for 5 seconds to turn on the Rugby in pairing mode. The Rugby beeps five times slowly.
3.	Press and hold the Power Button on the Receiver until pairing is confirmed.
	When the pairing is successful: Both the Rugby and the Receiver beep five times and the LEDs are flashing (green). There is no confirmation on the LCD displays during this process.
	When the pairing is <b>not</b> successful: The Status LED on the Rugby flashes (red) quickly five times.

---

# 6

## Rugby 870/880 Menu

### 6.1

### Access and Navigation

#### Description

The Rugby 870/880 has several menu options that allow you to optimise the performance of the Rugby for an individual application.

To access the menu of the Rugby 870/880, press the Left and Right Arrow Buttons simultaneously while the main screen is displayed.

#### Navigation within the Menu:

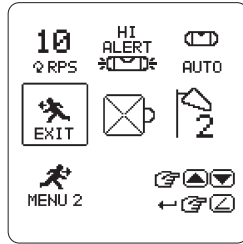

In the bottom right-hand corner of the menu screen, there are displayed User Direction buttons to indicate the navigation within the Rugby menu.

Press the Up and Down Arrow Buttons to move the cursor and highlight an icon or an option.

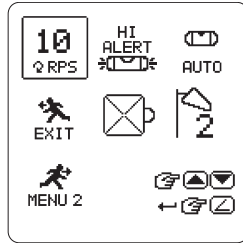

*A highlighted icon is surrounded by a box.*

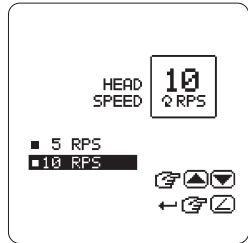

*A highlighted option is shaded in black.*

Press the Grade Button to select a highlighted icon or to enable/disable a highlighted option.

- If you select an icon, a screen with the options for the selected icon is displayed.
- If you select the menu icon (MENU 1, MENU 2, MENU 3), the next menu set is displayed.
- If you select the EXIT icon, the system returns to the main screen.

Overview

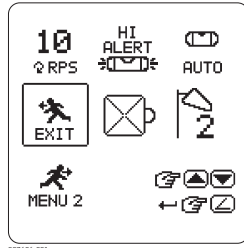

Menu Set 1

In the Menu Set 1, you can select the following parameters:

- Head Speed settings
- H.I.Alert - On/Off
- Automatic/Manual Modes
- Sensitivity settings
- Beam Masking

- ☞ To exit the menu, highlight and select the EXIT icon. OR: Wait for 8 seconds and the menu is exited automatically.
- ☞ To display the Menu Set 2, highlight and select the MENU 2 icon.

Head Speed Settings

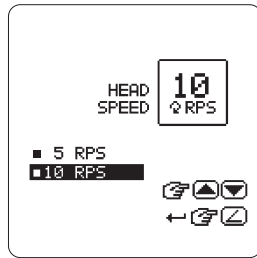

Head Speed Settings

You can select three head speed settings:

- 5 rps
- 10 rps

H.I.Alert - On/Off

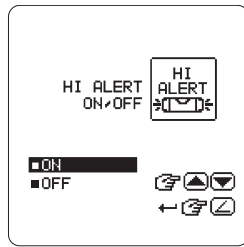

H.I.Alert Settings

You can choose to enable or disable the H.I.Alert function:

- On
- Off

When enabled, the H.I.Alert function turns on automatically every time the Rugby is turned on. The function becomes active 30 seconds after turning on the Rugby.

How does the H.I.Alert function work?

The Height of Instrument (H.I.) or Elevation Alert function prevents incorrect work caused by movement or settling of the tripod that would cause the laser to level at a lower height.

30 seconds after the Rugby has levelled and the head of the laser starts rotating, the H.I.Alert function becomes active.

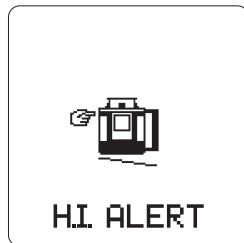

H.I.Alert screen

The H.I.Alert function monitors the movement of the laser; if disturbed, the H.I.Alert screen flashes and the Rugby beeps rapidly.

To stop the alert, turn the Rugby off and on again. Check the height of the laser before beginning to work again.

## Automatic/Manual mode

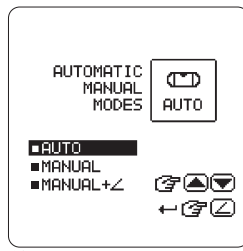

Automatic/Manual Mode Settings

You can select from three different modes:

- Automatic mode (default)
- Manual mode
- Manual mode with grade

You can choose to disable the automatic self-levelling mode.

Note: The Rugby always turns on in automatic mode regardless of the previous selection.

### Automatic Mode

The Rugby always turns on in automatic mode and continuously self-levels to maintain grade accuracy.

### Manual Mode

In manual mode the self-levelling function is turned off. The Manual Mode screen is displayed instead of the normal main screen.

The plane of laser light can be manually sloped using the same buttons as for direct grade entry, but no value for the grade is shown in the display.



Manual Mode screen

### Manual Mode with Grade

In manual mode with grade the self-levelling function is turned off. The Manual Mode with Grade screen is displayed instead of the normal main screen.

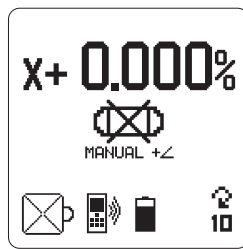

Manual Mode with Grade - X-axis

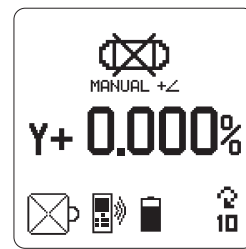

Manual Mode with Grade - Y-axis

The plane of laser light can be manually sloped using the same buttons as for direct grade entry. The value of the entered grade is displayed in the Manual Grade Entry screens.

When using this mode, the Rugby first levels to the selected grade, then returns to manual mode.



Manual Grade Entry - X-Axis



Manual Grade Entry - Y-Axis



## Sensitivity Settings

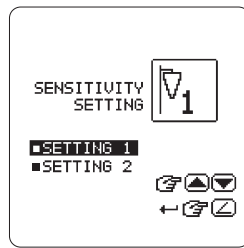

Sensitivity Variable Screens

While levelling, the Rugby responds to disturbances (wind, vibrations) and stops the head rotation, if necessary. You can choose between two levels of sensitivity:

- Sensitivity Setting 1: For normal performance - wind, vibration and other disturbances are minimal.
- Sensitivity Setting 2: For situations when wind, vibration and other disturbances are more severe.

When enabled, the H.I.Alert function turns on automatically every time the Rugby is turned on. The function becomes active 30 seconds after turning on the Rugby.

## Beam Masking

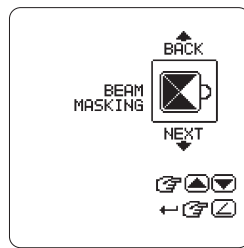

Beam Masking Screen

Beam masking allows you to turn off the laser beam on selected sides of the laser to prevent interference with other lasers or receivers that could be working in the same working area.

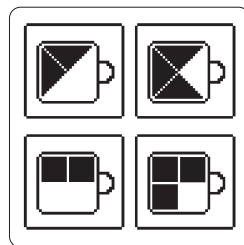

Possible combinations

You can choose to block half or three quarters of the rotating laser beam.

Each of the four displayed combinations is available in four different variants. The dark area represents the area where the laser beam is turned off.

Use the Up or Down Arrow Buttons to choose from the 16 possible combinations.

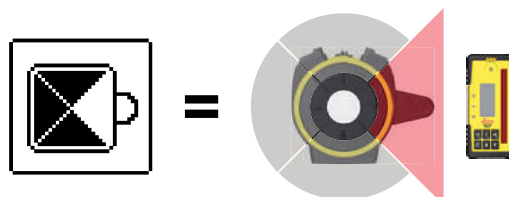

008451.001

## 6.3

## Menu Set 2

### Overview

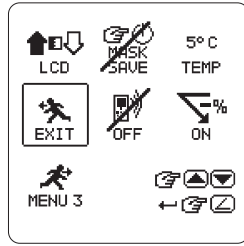

Menu Set 2

In the Menu Set 2, you can select the following parameters:

- Display Brightness
- Beam masking - Save at power off
- Temperature Sensitivity
- Negative Grade - enable/disable
- Radio - enable/disable

 To exit the menu, highlight and select the EXIT icon. OR: Wait for 8 seconds and the menu is exited automatically.

 To display the Menu Set 3, highlight and select the MENU 3 icon.

### Display Brightness

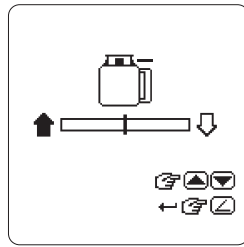

Display Brightness screen

With this setting, you can change the display brightness. Use the Up and Down Arrow Buttons to adjust the brightness as desired.

### Save Beam Masking at Power Off



Save Beam Masking screens

Normally, the beam masking setting is disabled every time you turn off the Rugby.

If you prefer to save the beam masking settings for usage on the following day, you can enable the saving of the beam masking setting:

- Save: The beam masking settings are saved at power off.
- Don't save: The beam masking settings are disabled at power off.

## Temperature Sensitivity Settings

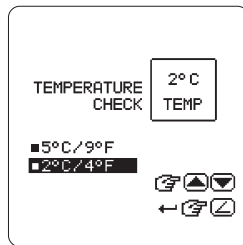
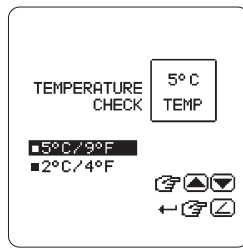

Temperature Check Settings screens

For each change in temperature of  $\pm 5^{\circ}\text{C}$  ( $\pm 9^{\circ}\text{F}$ ) the Rugby 870/880 returns to the level position to check if the change in temperature has led to a change of the main levelling system.

For a more sensitive unit, you can change the setting to  $\pm 2^{\circ}\text{C}$  ( $\pm 4^{\circ}\text{F}$ ) temperature change.

Available intervals:

- Temperature is checked every  $5^{\circ}\text{C}/9^{\circ}\text{F}$
- Temperature is checked every  $2^{\circ}\text{C}/4^{\circ}\text{F}$

## Relevelling process

When the Rugby is relevelling, the Temperature Check Wait screen is displayed. Wait until the process is finished before using the laser again. The Status LED flashes to indicate normal levelling.

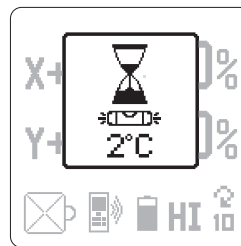
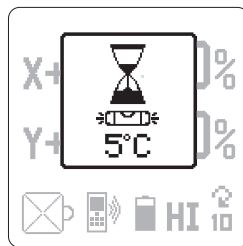

Temperature Check Wait screens

## Negative Grade - Enable/Disable

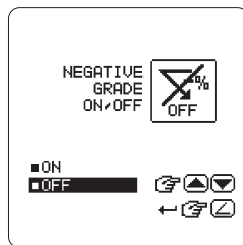
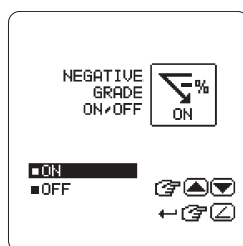

Negative Grade screens

If you want to prevent confusion when setting up the laser, you can disable the negative grade function on the Rugby.

- ON: Negative grade is enabled.
- OFF: Negative grade is disabled.

When negative grade is disabled, only positive grade can be entered in the direction of the arrow-shaped alignment marks on the top of the Rugby.

## Radio - Enable/Disable

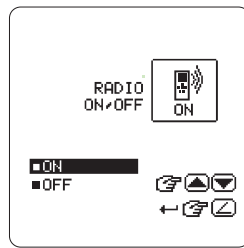

007631.001

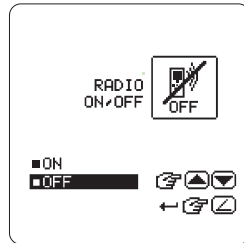

007632.001

Radio screens

To be able to communicate with the RC800 remote control and the Rod Eye 180 receiver, the radio on the Rugby must be enabled. The radio is automatically enabled when the units are paired together.

- ON: Radio is enabled.
- OFF: Radio is disabled.

☞ If you do not use the RC800 remote control or the Rod Eye 180 receiver, it is recommended to disable radio in order to save battery life.

## 6.4

### Menu Set 3

#### Overview

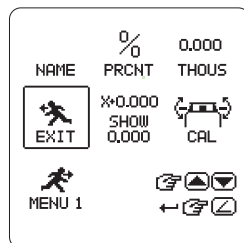

007633.001

Menu Set 3

In the Menu Set 3, you can select the following parameters:

- Customer Name Entry
- Display - Percent/Per Mil
- Display - Thousandths/Hundredths
- Show Grade Settings on power up
- Calibration Alert - enable/disable

☞ To exit the menu, highlight and select the EXIT icon. OR: Wait for 8 seconds and the menu is exited automatically.

☞ To display the Menu Set 1, highlight and select the MENU 1 icon.

## Customer Name Settings

The Customer Name settings allow you to enter the customer's name, to enable/disable the customer name screen when turning on the Rugby, and to protect the name entry with a password.

### Customer Name Entry

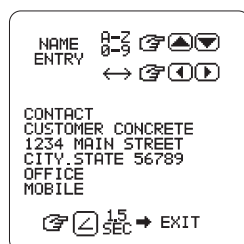

007634.001

Customer Name Entry screen

When entering the Customer Name settings the first time, you are taken directly to the Customer Name entry screen. On this screen, you can enter 6 lines of text with up to 20 characters per line.

It is recommended to determine the desired text before changing or entering the information:

To save the entered information, press and hold the Grade Button for 1.5 seconds.

### Enable/Disable the Display Name on Start-up

After saving the name entry, the Display Name on Start-up screen is displayed. You can choose between two options:

- Display (YES): The Customer Name screen is displayed each time the laser is turned on.
- Save only (NO): The information entered in the Customer Name screen is stored in the laser, but is only visible when the Customer Name entry screen is accessed.

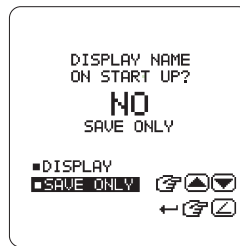
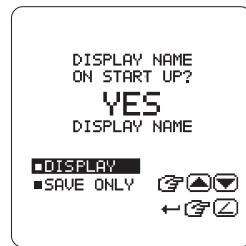

Display Name on Start-Up screens

### Protect Customer Name Entry with a Password

After selecting the Display on Start-up setting, you can choose to enable/disable the password protection of the Customer Name entry screen:

- YES: Password protection is enabled. Enter a four-digit password. The password is required each time you access the customer name entry screen.
- NO: Password protection is disabled.

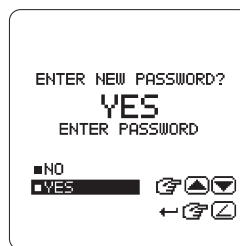

New Password screens

## Display - Percent/Per Mil

You can choose to display the grade in percent of grade or per mil:

- 1.000% = 1 metre rise per 100 metres
- 1.00‰ = 1 metre rise per 1000 metres

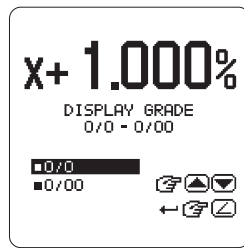

007639.001

Display Percent

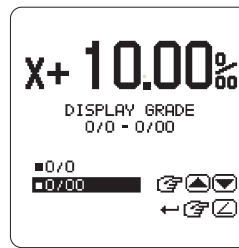

007640.001

Display per Mil

Standard usage is percent of grade.

You are asked to confirm the selected option to prevent unwanted changes and possible errors due to the shift of the decimal point.

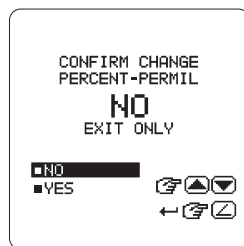

007641.001

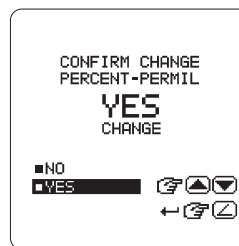

007642.001

Per Mil - Confirmation Screens

## Display - Thousandths or Hundredths

You can choose to display percent of grade in thousandths or hundredths:

- 1.000 - Standard usage is to display thousandths or three digits after the decimal point.
- 1.00 - If you choose to display hundredths, only two digits are displayed after the decimal point.

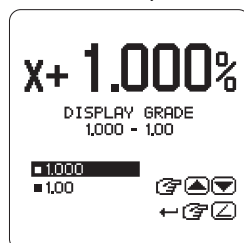

007643.001

Display Thousandths

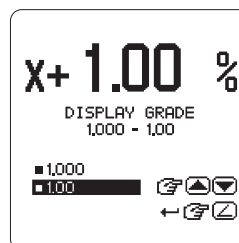

007644.001

Display Hundredths

## Show Grade Settings on Power Up

Normally, the grade value is reset to 0.000% every time you turn on the Rugby. If you prefer to display the previous grade settings when turning on the Rugby, you can enable the option **Show Grade**.

- Show 0.000: The grade settings are reset to 0.000% on power up (default).
- Show Grade: The previous grade settings are displayed on power up.

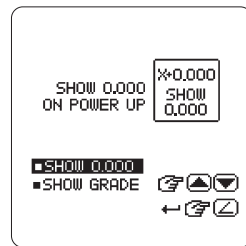

Show 0.000%

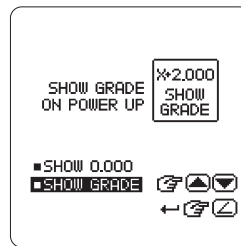

Show Grade

 Note: When the option **Show 0.000%** is selected and you want to restore the last set grade(s), press and hold the Grade Button for 1.5 seconds.

## Calibration alert activation

### Enabling/Disabling the Calibration Alert Function

You can choose to enable/disable a calibration alert function based on hours of use:

- ON: Calibration alert is enabled
- OFF: Calibration alert is disabled

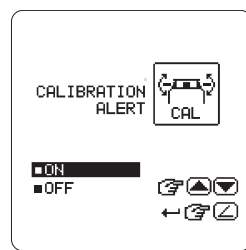

Enable Calibration Alert Screen

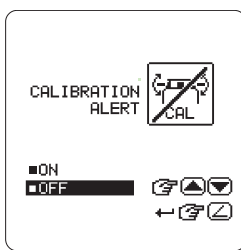

Disable Calibration Alert Screen

### Setting the Hours for Calibration Alert

If you enabled the calibration alert function, the "Set Calibration Alert Hours" screen is displayed. The default setting is 1.040 hours, which corresponds to approximately 6 months, based on a 40-hour working week.



Set Calibration Alert Hours Screen

Set the number of hours you would like to work before receiving a calibration alert.

The hours can be set in increments of 40 hours.

## Display of Calibration Alert on Start-up Screen

If you enabled the calibration alert function, the calibration alert hours are displayed on the start-up screen after turning on the Rugby:

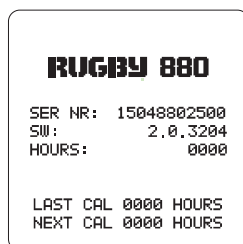

- LAST CAL: The number of hours since the last calibration.
- NEXT CAL: The number of hours remaining until the next calibration is planned.

### Calibration Alert Hours on Start-up Screen

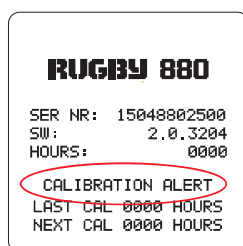

When the number of planned hours is reached, the words "CALIBRATION ALERT" are displayed for 8 seconds.

After calibrating the Rugby, the calibration alert hours are automatically reset. Changing or disabling the calibration alert is only possible by accessing the menu option "Calibration alert activation".

### Calibration Alert Flashing Screen



## Overview



Remote Control Menu Screen

The RC800 Remote Control has its own menu where you can change the following parameters:

- Display Brightness
- Sleep Mode Hours
- Remote Shut-Off Time

 To access the Remote Control menu, press and hold the Left and Right Arrow Buttons on the remote control for 1.5 seconds.

 For navigation within the Remote Control menu, use the same buttons as for navigation within the Rugby menu. (Refer to "6.1 Access and Navigation")

## Display Brightness

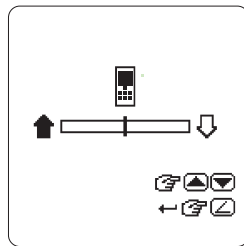

Remote Control Display Brightness

You can change the display brightness on this screen. Use the Up and Down Arrow Buttons to adjust the brightness as desired.

## Sleep Mode Hours



Sleep Mode Hours

You can determine how long the Rugby stays in sleep mode before turning off completely:

- 2 hours
- 4 hours
- 8 hours
- 16 hours

## Remote Shut-Off Time

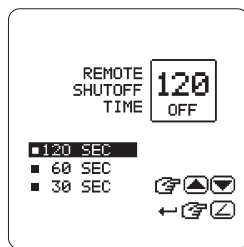

Shut-Off Time

You can determine a shut-off time for the remote control:

- 30 seconds
- 60 seconds
- 120 seconds

If the remote control is not used during this time, it shuts off automatically.

# 8 Applications

## 8.1 Setting Forms

### Setting Forms step-by-step

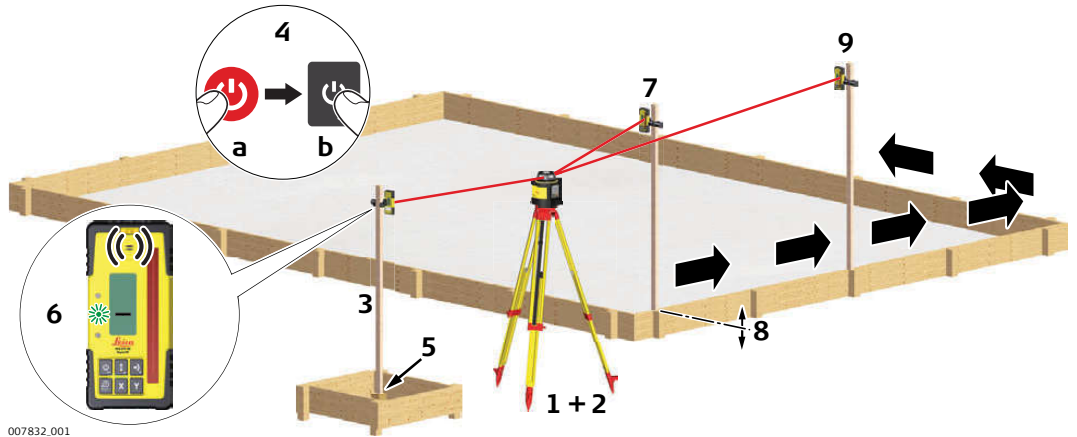

007832.001

Step	Description
1.	Set up the Rugby on a tripod.
2.	Set up the tripod on a stable surface outside the working area.
3.	Attach the receiver to a rod.
4.	Turn on the Rugby and the receiver.
5.	Set the base of the rod on a known point for the finished height of forms.
6.	Adjust the height of the receiver on the rod until the on-grade (centre-line) position is indicated on the receiver by: <ul style="list-style-type: none"> <li>• the centre bar</li> <li>• the green flashing LED</li> <li>• a solid audio tone</li> <li>• the digital display</li> </ul>
7.	Set the rod with the attached receiver on top of the form.
8.	Adjust the height of the form until the on-grade position is again indicated.
9.	Continue to additional positions until the forms are levelled to the rotating plane of the Rugby.

## 8.2

## Checking Grades

### Checking Grades step-by-step

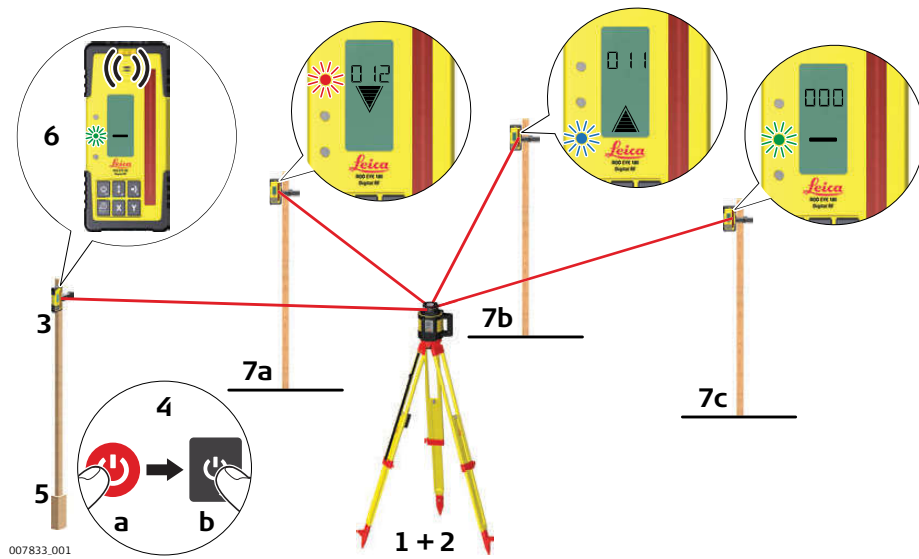

Step	Description
1.	Set up the Rugby on a tripod.
2.	Set up the tripod on a stable surface outside the working area.
3.	Attach the receiver to a rod.
4.	Turn on the Rugby and the receiver.
5.	Set the base of the rod on a known point for the finished grade.
6.	Adjust the height of the receiver on the rod until the on-grade (centre-line) position is indicated on the receiver by: <ul style="list-style-type: none"> <li>• the centre bar</li> <li>• the green flashing LED</li> <li>• a solid audio tone</li> <li>• the digital display</li> </ul>
7.	Set the rod with the attached receiver on top of the excavation or concrete pour to check for correct elevation.
8.	Variations can be read in precise measurements with the digital receiver. <ul style="list-style-type: none"> <li>• 7a: Position is too high.</li> <li>• 7b: Position is too low.</li> <li>• 7c: Position is on grade.</li> </ul>

## 8.3

## Entering Grades

### Entering Grades step-by-step

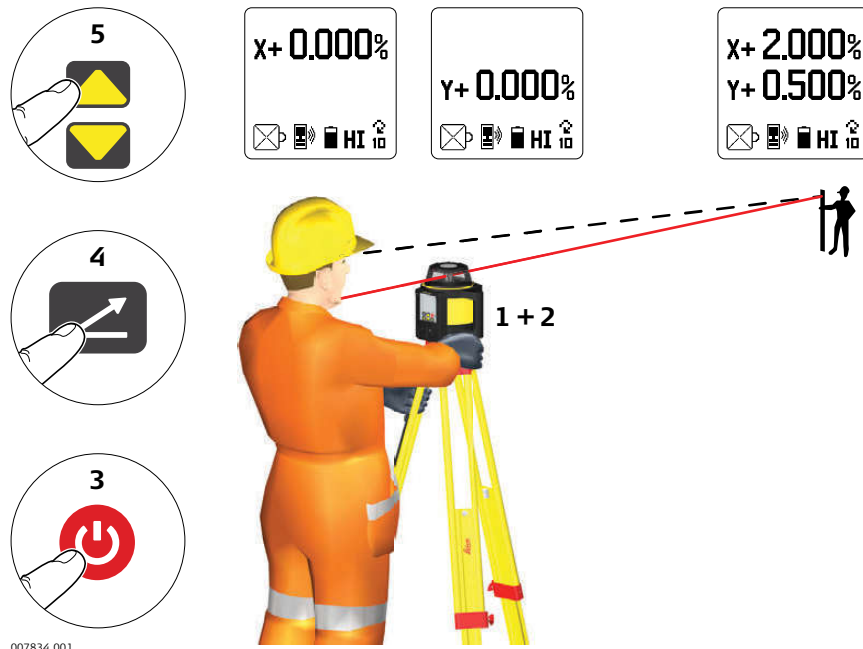

007834\_001

Step	Description
1.	Set up the Rugby on a tripod.
2.	Set up the Rugby and the tripod in line with one axis of the job and align the top of the Rugby in the direction of the axis.
3.	Turn on the Rugby.
4.	Press the Grade button.
5.	Press the Up or Down Arrow Button to enter grade for the x-axis (single slope). <ul style="list-style-type: none"> <li>For Rugby 870: To exit grade entry mode, press the Grade Button until the main display is shown.</li> <li>For Rugby 880: To enter grade for the y-axis, press the Grade button a second time. To exit grade entry mode, press the Grade Button until the main display is shown.</li> </ul>
6.	Once grade is entered, the Rugby begins to adjust to grade. Do not disturb the Rugby during this process.

 To reset the grade value to zero while in grade entry mode, press the Up and Down Arrow Buttons simultaneously.

 To restore the last set grade(s), press and hold the Grade Button for 1.5 seconds.



## 8.4

## Smart Targeting (Grade Matching)

### Smart Targeting step-by-step using the Rod Eye 180

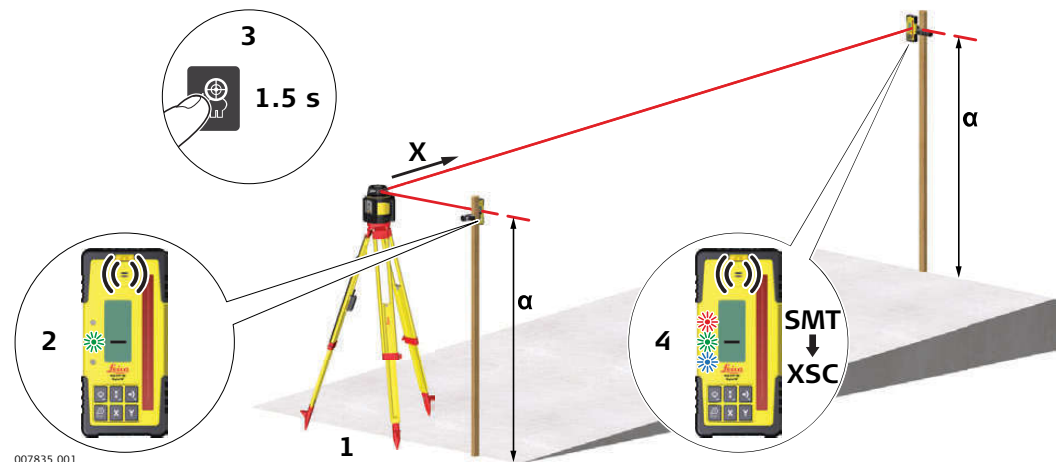
Using the Smart Target feature you can match an existing grade. The Rugby moves to the new grade position, displays the grade found and begins self-levelling to maintain the grade over time. Maximum range is 100 m (300').



Step	Description
1.	Set up the Rugby 870/880 at the base of a slope with no grade dialled into the Rugby and with the X-axis pointing in the direction of the slope.
2.	Adjust the height of the receiver on the rod at the base of the slope until the on-grade (centreline) position is indicated on the receiver by: <ul style="list-style-type: none"> <li>the centre bar</li> <li>the green flashing LED</li> <li>a solid audio tone</li> <li>the digital display</li> </ul>
3.	Move the rod with the receiver to the top of the slope. To start the Smart Targeting process press the laser man button for 1.5 seconds. The receiver shows <b>SMT</b> , then <b>XSC</b> for X-axis slope catching.
	The Rugby 870/880 searches for the receiver until the on-grade position is found. Once the on-grade position is found, the receiver flashes all three LEDs simultaneously one time and the receiver returns to normal operation.
4.	After this signal, the receiver can be moved and used as normal. The grade for the sloped axis is displayed on the LCD and the Rugby now self-levels to this new slope.
	To use Smart Targeting for the Y-axis, press the Y Button together with the Laser Man Button for 1.5 seconds until the receiver shows <b>YSC</b> for Y-axis slope catching.
	Using this procedure, you can set up either one or both axes.

## 8.5

## Smart Target Lock (Grade Matching and Monitoring)

### Smart Target Lock step-by-step using the Rod Eye 180

Using the Smart Target Lock feature, you can match an existing grade. The Rugby moves to the new grade position, displays the grade found and begins self-levelling to maintain the grade over time. Maximum range is 100 m (300').

Pressing and holding the Laser Man Button for 5 seconds rather than 1.5 seconds starts the Rod Eye 180 in lock mode. The Rod Eye 180 must remain in place to monitor any movements of the rotating beam. Thus, an accurate grade setup is maintained.

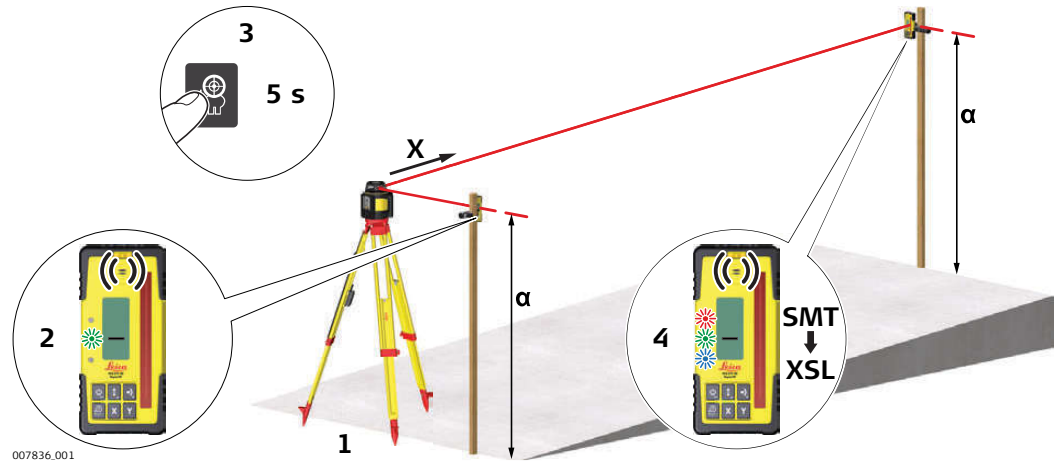

Step	Description
1.	Ensure that the grade value is set to zero. Set up the Rugby 870/880 at the base of a slope with the X-axis pointing in the direction of the slope.
2.	At the base of the slope, adjust the height of the Rod Eye 180 receiver on the rod until the on-grade (centreline) position is indicated on the receiver by: <ul style="list-style-type: none"> <li>the centre bar</li> <li>the green flashing LED</li> <li>a solid audio tone</li> <li>the digital display</li> </ul>
3.	Move to the top of the slope and press the Laser Man Button for 5 seconds to start the smart target and lock process. The receiver shows <b>SMT</b> , then <b>XSL</b> during the X-axis slope catching and lock process.
	The Rugby 870/880 searches for the receiver until the on-grade position is found. Once the on-grade position is found, the receiver flashes all three LEDs simultaneously one time. The display shows <b>LOC</b> while the receiver is in lock mode.
4.	After this signal, the receiver must remain in place to monitor any movements of the rotating beam. The grade for the sloped axis is displayed on the LCD display of the Rugby.
	To use Smart Target Lock for the Y-axis, press the Y Button together with the Laser Man Button for 5 seconds until the receiver shows <b>YSC</b> , then <b>YSL</b> during the Y-axis slope catching and lock process.
	To turn off lock mode on the receiver, hold the Power Button for 1.5 seconds.
	Using this procedure, you can monitor either one or both axes.
	To lock and monitor the rotating beam of an existing grade, mount the receiver in the plane of the laser before starting the Smart Target Lock procedure.

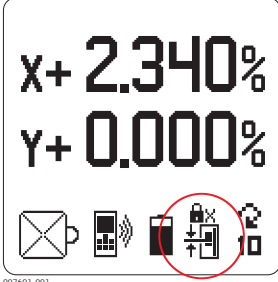
Step	Description
	<p>When one or both axes are in lock mode, a small icon appears on the display instead of the H.I. symbol to indicate that lock mode is activated.</p>  <p>007601_001</p>

## 8.6 Automatic Axis Alignment

### Description

The automatic axis alignment electronically adjusts the axes of the Rugby to your grade stakes. The procedure is the same as the procedure described in "3.8 Precise Alignment of the Axes" - except that the alignment is done electronically, using the Rod Eye 180 receiver.

For the automatic axis alignment, it is only necessary to position the laser and receiver in line with two grade stakes and to start the procedure. The following steps are done automatically:

- The Rugby searches for the receiver on the Y-axis until it is found and locked on grade.
- Once found, the Rugby drives grade into the X-axis and monitors the position of the beam on the receiver.

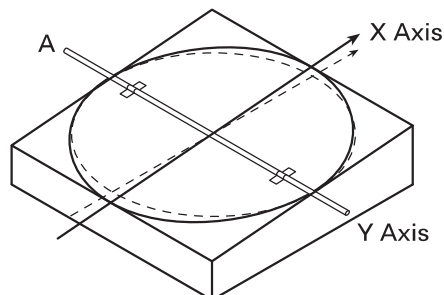

- The Rugby electronically compensates for any misalignment by adjusting the beam until it is again locked on the Rod Eye 180 receiver.
- The procedure is then complete and the Rugby returns to the grades that you entered. The laser is now properly aligned.

### Step-by-Step

Step	Description
1.	Dial in the required grade for the X- and Y-axis (Rugby 870: X-axis only).
2.	Position the Rugby at Point A in line with the Y-axis. Alternatively, the laser can also be aligned to the X-axis.
3.	Roughly align the Y-axis using the alignment marks on top of the Rugby.
	Position the Rod Eye 180 Receiver also in line with the Y-axis. The height of the receiver is not important for this procedure. Maximum range is 100 m (300').
4.	To start the automatic alignment of the Y-axis, press the Y Button on the Rod Eye 180 Receiver for 5 seconds. <i>The Rugby starts searching for the receiver. The Rod Eye 180 displays AAY (Axis Alignment Y-axis) during the alignment procedure.</i>

Step	Description
	<p><i>The automatic alignment procedure takes approximately 2 minutes.</i></p> <p> Ensure that the Rod Eye 180 is held steady until the procedure is complete!</p>
5.	<p>If the procedure is successful: The Rod Eye 180 turns on all three LEDs for one second, then returns to normal operation.</p> <p>If the procedure is <b>not</b> successful: The Rod Eye 180 flashes all three LEDs ten times slowly, then shuts off.</p>

### Information screens during alignment procedure

During and after the alignment procedure the Rugby displays information screens to indicate the status of the procedure.

During the alignment procedure, the WAIT screen is displayed.

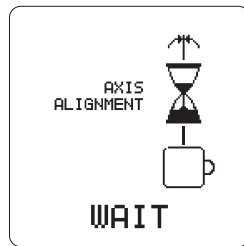

When the alignment procedure is successful, the Rugby displays the COMPLETE screen for 8 seconds, then resumes normal operation.

On the main display, the Axis Aligned icon replaces the Remote icon.

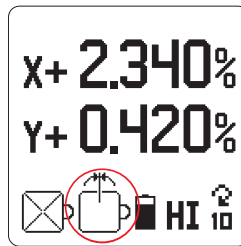
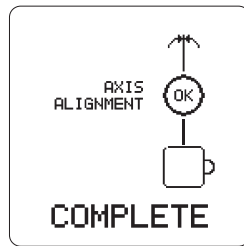

If the alignment procedure is not successful, the Rugby displays the ERROR screen for up to 2 minutes, then shuts down.

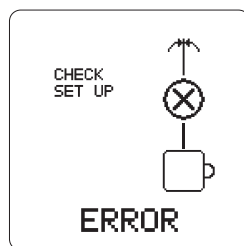



## 8.7

### Axis Alignment plus Smart Target Lock (Axis Alignment and Monitoring)

If you also want the receiver to monitor the beam after the axis alignment, you have to place the receiver's on grade position exactly in the plane of the laser and start the Smart Target Lock process.

Refer to "8.5 Smart Target Lock (Grade Matching and Monitoring)".

## 8.8









### Dual Receiver Setups

#### Dual Receiver setups using the Rugby 870/880

It is possible to use the Smart Targeting feature of the Rod Eye 180 Digital RF Receiver to catch and monitor both axes of the laser. To do this, perform the actions above for the first axis, and then repeat the actions for the second axis using a second receiver.

- ☞ To use the Smart Target feature to slope catch and monitor both axes, it is necessary to have two receivers.
- ☞ Once the lock and monitoring process is started, the receivers must remain in place.

Individual axis can be selected for the Smart Targeting procedure by first pressing the X or Y button on the receiver keypad and the laser man button.

Action	Buttons
To slope catch the X-axis: Press <b>X</b> plus Laser Man for 1.5 seconds	1x  +  1.5 s
To slope catch and lock the X-axis: Press <b>X</b> plus Laser Man for 5 seconds.	1x  +  5 s
To slope catch the Y axis: Press <b>Y</b> plus Laser Man for 1.5 seconds.	1x  +  1.5 s
To slope catch and lock the Y-axis: Press <b>Y</b> plus Laser Man for 5 seconds.	1x  +  5 s

---

<b>Description</b>	The Rugby 870/880 can be purchased with alkaline batteries or a rechargeable Li-Ion battery pack. The following information is appropriate only to the model you have purchased.
--------------------	-------------------------------------------------------------------------------------------------------------------------------------------------------------------------------------

---

## 9.1 Operating Principles

---

<b>Charging / first-time use</b>	<ul style="list-style-type: none"> <li>• The battery must be charged prior to using it for the first time because it is delivered with an energy content as low as possible.</li> <li>• The permissible temperature range for charging is between 0°C to +40°C/ +32°F to +104°F. For optimal charging, we recommend charging the batteries at a low ambient temperature of +10°C to +20°C/+50°F to +68°F if possible.</li> <li>• It is normal for the battery to become warm during charging. Using the chargers recommended by Leica Geosystems, it is not possible to charge the battery if the temperature is too high.</li> <li>• For new batteries or batteries that have been stored for a long time (&gt; three months), it is effectual to make only one charge/discharge cycle.</li> <li>• For Li-Ion batteries, a single discharging and charging cycle is sufficient. We recommend carrying out the process when the battery capacity indicated on the charger or on a Leica Geosystems product deviates significantly from the actual battery capacity available.</li> </ul>
<b>Operation / Discharging</b>	<ul style="list-style-type: none"> <li>• The batteries can be operated from -20°C to +55°C/-4°F to +131°F.</li> <li>• Low operating temperatures reduce the capacity that can be drawn; high operating temperatures reduce the service life of the battery.</li> </ul>

---

## 9.2

## Battery for Rugby

### Charging the Li-Ion battery pack step-by-step

The rechargeable Li-Ion battery pack on the Rugby can be charged without removing the battery pack from the laser.



Step	Description
1.	Slide the locking mechanism on the battery compartment to the left to expose the charge jack.
2.	Plug the AC connector into the appropriate AC power source.
3.	Connect the charger plug into the charge jack on the Rugby battery pack.
4.	The small LED next to the charge jack flashes indicating that the Rugby is charging. The LED is on solid when the battery pack is fully charged.
5.	When the battery pack is fully charged, disconnect the charger plug from the charge jack.
6.	Slide the locking mechanism to the centre position to prevent dirt from getting into the charging jack.





The battery pack reaches a full charge in approximately 5 hours if completely empty. A one-hour charge should allow the Rugby to run for a full 8 hours.

**Changing the Li-Ion batteries step-by-step**

With the rechargeable Li-Ion battery pack the battery indicator on the Rugby LCD display shows when the battery pack is low and needs to be charged. The charge indicator LED on the Li-Ion battery pack indicates when the pack is being charged (flashing slowly) or fully charged (on, not flashing).



007838.001



Step	Description
	The batteries are inserted in the front of the laser.
	The rechargeable battery pack can be recharged without being removed from the laser. Refer to "Charging the Li-Ion battery pack step-by-step" for further information.
1.	Slide the locking mechanism on the battery compartment to the right and open the cover of the battery compartment.
2.	To remove the batteries: Remove the batteries from the battery compartment.
	To insert the batteries: Insert the batteries into the battery compartment.
3.	Close the cover of the battery compartment and slide the locking mechanism to the left centre position until it locks into position.

**Changing the alkaline batteries step-by-step**

With alkaline batteries the battery indicator on the Rugby LCD display flashes when the batteries are low and need to be replaced. If no battery icon is shown, the batteries are okay.



007839.001

Step	Description
	The batteries are inserted in the front of the laser.
1.	Slide the locking mechanism on the battery compartment to the right and open the cover of the battery compartment.
2.	To remove the batteries: Remove the batteries from the battery compartment.
	To insert the batteries: Insert the batteries into the battery compartment, ensuring that the contacts are facing in the right direction.  The correct polarity is displayed on the battery holder.
3.	Close the cover of the battery compartment and slide the locking mechanism to the left until it locks into position.

# 10

## Accuracy Adjustment

### About

- It is the responsibility of the user to follow operating instructions and to periodically check the accuracy of the laser and work as it progresses.
- The Rugby is adjusted to the defined accuracy specification at the factory. It is recommended to check the laser for accuracy upon receipt and periodically thereafter to ensure accuracy is maintained. If the laser requires adjustment, contact your nearest authorised service centre or adjust the laser using the procedures described in this chapter.
- Only enter the accuracy adjustment mode when you plan to change the accuracy. Accuracy adjustments should only be performed by a qualified individual that understands basic adjustment principles.
- It is recommended to perform this procedure with two people on a relatively flat surface.

### 10.1

### Checking the Level Accuracy

#### Checking the level accuracy step-by-step

Step	Description
1.	Place the Rugby on a flat, level surface or tripod approximately 30 m (100 ft) from a wall.
2.	Align the first axis so that it is square to a wall. Allow the Rugby to self-level completely (approximately 1 minute after the Rugby begins to rotate).
3.	Mark the position of the beam.
4.	Rotate the laser 180° and allow it to self-level.
5.	Mark the opposite side of the first axis.
6.	Align the second axis of the Rugby by rotating it 90° so that this axis is square to the wall. Allow the Rugby to self-level completely.

Step	Description
7.	Mark the position of the beam.
8.	Rotate the laser 180° and allow it to self-level.
9.	Mark the opposite side of the second axis.

 The Rugby is within its accuracy specification if the four marks are within  $\pm 1.5$  mm ( $\pm 1/16$ ") from the centre.

## 10.2 Adjusting the Level Accuracy

### Description

In Calibration mode the X-axis calibration screen indicates changes to the X-axis.



007842.001

The Y-axis calibration screen indicates changes to the Y-axis.

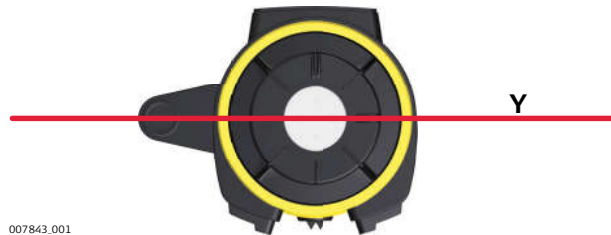

007843.001

### Entering Calibration mode step-by-step

Step	Description
1.	Turn off the power.
2.	Put the Rugby in an upright position.
3.	Press and hold both the Up and Down Arrow buttons.
4.	Press the Power button. The X-axis calibration screen appears. The Rugby is now in Calibration mode.

 In Calibration mode, the LED does not blink and the laser head continues to rotate. An hour-glass indicates that the Rugby is levelling.

### Calibrating the X-axis step-by-step

When entering Calibration mode, the X-axis calibration screen appears:

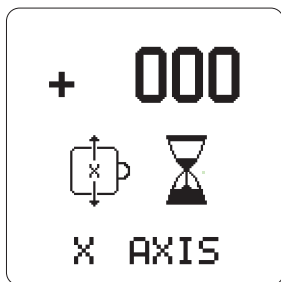

Step	Description
1.	When the hour glass has disappeared, indicating that the Rugby has levelled, check both sides of the X-axis.
2.	Press the Up and Down Arrow Buttons to bring the plane of laser light to the specified level position.  Each step represents approximately 2 arc seconds of change. Therefore, 5 steps equal approximately 1.5 mm at 30 m (1/16" at 100').
3.	Press the Grade Button to accept the adjusted position and to switch to the Y-axis calibration screen.

### Calibrating the Y-axis step-by-step

After calibration of the X-axis, the Y-axis calibration screen appears:



Step	Description
1.	When the hour glass has disappeared, indicating that the Rugby has levelled, check both sides of the Y-axis.
2.	Press the Up and Down Arrow Buttons to bring the plane of laser light to the specified level position.  Each step represents approximately 2 arc seconds of change. Therefore, 5 steps equal approximately 1.5 mm at 30 m (1/16" at 100').
3.	Press the Grade Button to accept the adjusted position and to switch to the X-axis calibration screen.
4.	Press and hold the Grade Button for 3 seconds to accept the adjusted positions, save and store the calibration settings and return to the Main User screen.

### Exiting Calibration mode

Press and hold the Grade button for 3 seconds to save and exit Calibration mode.



Pressing the Power button at any time while in Calibration mode will exit the mode without saving changes.



## 10.3

### Adjusting the Vertical Accuracy

#### Entering Calibration mode for the Z-axis step-by-step

Step	Description
1.	Turn off the power.
2.	Put the Rugby in laydown position.
3.	With power off, press and hold both the Up and Down Arrow Buttons.
4.	Press the Power Button. The active axis is the Z-axis.

 In Calibration mode, the LED does not blink and the laser head continues to rotate. An hour-glass indicates that the Rugby is levelling.

#### Calibrating the Z-axis step-by-step

When entering calibration mode for the Z-axis, the Z-axis calibration screen appears:

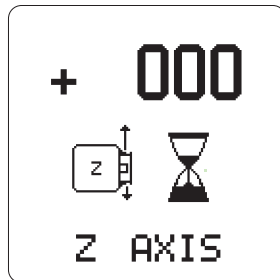

Step	Description
1.	Press the Up and Down Arrow Buttons to increment the vertical position of the laser beam.
2.	Continue to press the Left and Right Arrow Buttons and monitor the beam until the Rugby is within its specified range.
3.	Press and hold the Grade Button for 3 seconds to accept the adjusted position, to save and store the calibration settings and to return to the main user screen.

# 11

## Semi-Automatic Calibration

### About

This procedure is unique to the Rugby lasers and uses the digital readout of the Rod Eye 180 receiver to measure, then adjust the plane of each axis. This procedure is an alternative to the traditional method described in "10 Accuracy Adjustment".

### Description

Objective: To rotate the laser to all four axes, then allow the receiver to adjust the beam automatically.

### Setup

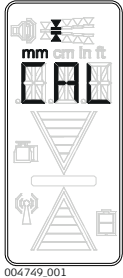
Step	Description
1.	Pair the receiver to the laser (if not already done). Refer to "5.3 Pairing the Rod Eye 180 with the Rugby 870/880" for more information.
2.	Mount the laser on a flat, level surface or tripod.
3.	Turn on the laser and align the X-axis toward the receiver position.
4.	Mount the receiver to a fixed position (e.g., a stationary grade rod) approximately 30 meters (100 ft) from the laser.
5.	Turn on the receiver and position the height of the receiver near or at the on-grade position. It is not necessary to be exact.
6.	Turn off the receiver.
7.	Turn on the receiver in <b>CAL</b> mode by pressing both the power and Laser man button for five seconds.
8.	The display will show <b>CAL</b> . 
9.	Return to the laser and note the colour and activity of the X and Y LEDs.



- With each rotation it may take up to 10 seconds for the calibration process to identify the axis being checked. Note the displayed screen indications.
- Each step of the process is very exact and may take 1 minute to complete before the ROTATE screen is displayed.
- It is important to note the screen indications to know the status of each axis in the process.
- It is not necessary to follow the steps in the exact order, but different rotation sequences result in different screen indications.
- Increasing the distance between the laser and receiver beyond 30 metres (100 ft) does not increase the accuracy of the calibration process.

**Calibrating step-by-step**

**Step 1 - Align the X-axis (X+) towards the Rod Eye 180**

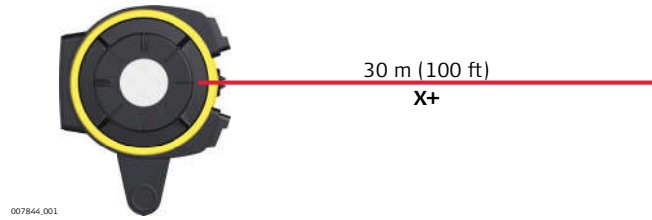

Screen Indication		Description
 X+ AXIS	 ROTATE 90°	While aligning, the Rugby displays an "hour glass" screen. When the axis is successfully aligned, a "ROTATE" screen is displayed on which the first axis shows "OK".

**Step 2 - Rotate the Rugby 90° and align Y-axis (Y-) towards the Rod Eye 180**

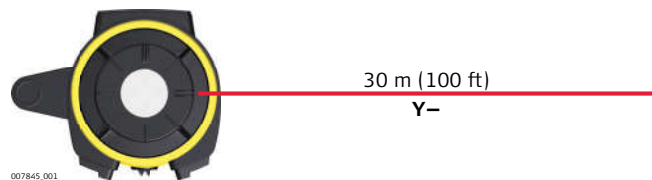

Screen Indication		Description
 Y- AXIS	 ROTATE 90°	While aligning, the Rugby displays an "hour glass" screen. When the axis is successfully aligned, a "ROTATE" screen is displayed on which the second axis shows "OK".

**Step 3 - Rotate the Rugby 90° and align X-axis (X-) towards the Rod Eye 180**

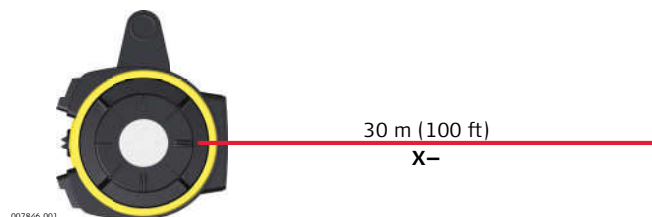

Screen Indication		Description
 X- AXIS	 ROTATE 90°	While aligning, the Rugby displays an "hour glass" screen. When the axis is successfully aligned, a "ROTATE" screen is displayed on which the third axis shows "OK".

**Step 4 - Rotate the Rugby 90° and align Y-axis (Y+) towards the Rod Eye 180**

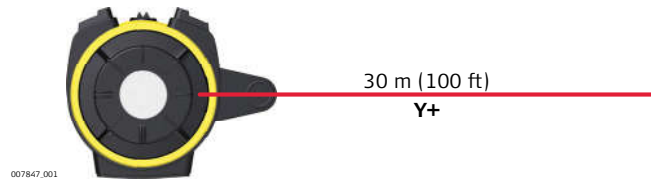

Screen Indication		Description
<p>Y+ AXIS</p>	<p>COMPLETE</p>	<p>While aligning, the Rugby displays an "hour glass" screen.</p> <p>When the axis is successfully aligned and the process is complete, a "COMPLETE" screen is displayed on which the fourth axis shows "OK".</p>

**Calibration successful:**





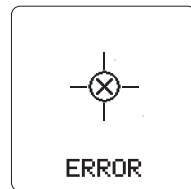

When all four axes have been checked and the calibration process was successful, the Rugby beeps at 5 Hz for 3 seconds, then shuts down.





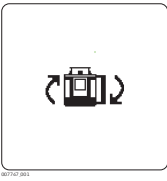
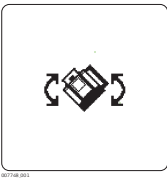
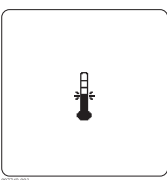

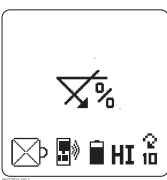
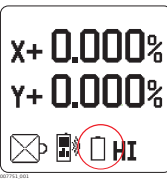

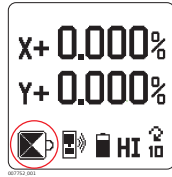

**Calibration not successful:**

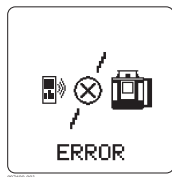
If the Rugby encounters a problem and the calibration process was not successful, the Rugby displays an "ERROR" screen for up to 2 minutes, then shuts off.

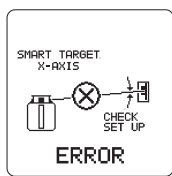

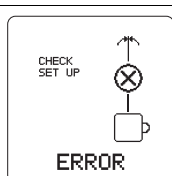
Alerts and Message Screens

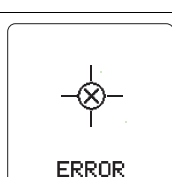
Alert	Symptom	Possible causes and solutions
	Low Battery indication on the display.	The batteries are low. Replace the alkaline batteries or recharge the Li-Ion battery pack. Refer to "9 Batteries".
	Elevation (H.I.) Alert The Elevation (H.I.) Alert screen is shown and the audio beeps. (Level position)	The Rugby has been bumped or tripod was moved. Turn off Rugby to stop alert, check the height of the laser before beginning to work again. Allow Rugby to relevel and check the height of the laser. After 2 minutes in the alert condition, the unit will shut off automatically.
	Servo Limit Alert The Servo Limit Alert screen is shown.	The Rugby is tipped too far to reach a level position. Relevel the Rugby within the 6 degree self-levelling range. After 2 minutes in the alert condition, the unit will shut off automatically.
	Tilt Alert The Tilt Alert screen is shown.	The Rugby is tipped more than 45° from level. After 2 minutes in the alert condition, the unit will shut off automatically.
	Temperature Alert The Temperature Alert screen is shown.	The Rugby is in an environment where it cannot operate without damaging the laser diode, for example being exposed to the heat from direct sunlight. Shade the Rugby from the sun. After 2 minutes in the alert condition, the unit will shut off automatically.
	Temperature Check The Temperature Check Alert screen is shown.	The Rugby has detected a change in temperature of 5°C and is checking the level position.  Wait until procedure is complete. Refer to " Temperature Sensitivity Settings" for changing the setting between 5°C and 2°C.
	Negative grade entry is not possible.	The negative grade function is disabled. Only positive grade can be entered in the Rugby. To enter negative grade, enable the negative grade function. Refer to " Negative Grade - Enable/Disable".
	The "empty battery" icon flashes.	The Rugby has reached a low battery condition and changes the head speed to 7rps. If the Rod Eye detects the Rugby rotating at 7 rps, it displays a small flashing Rugby.  Check the battery of the Rugby.

Alert	Symptom	Possible causes and solutions
	The beam is not emitting from all sides of the laser.	Beam masking is activated for two or more sides of the laser. To de-activate or change beam masking, refer to " Beam Masking".
	It is not possible to enter grade greater than 10.00% or 3.000%.	The Rugby allows for up to 10% grade entry in both axes simultaneously. If the grade entry for one axis is greater than 10%, the cross axis is limited to 3%.
	The Rugby is not communicating with the RC800 remote control.	The Rugby has lost the communication link to the remote control.  Ensure that you are within clear sight of the Rugby and that you have not exceeded the 100 m (300') working range.
	Smart Targeting does not work. The LEDs on the Rod Eye 180 are flashing ten times slowly.	The Smart Targeting procedure could not be completed.  Ensure that you are working on the correct axis and that you have not exceeded the 100 m (300') working range.
	Axis Alignment does not work. The LEDs on the Rod Eye 180 are flashing ten times slowly.	The Axis Alignment procedure could not be completed.  Ensure that you are working on the correct axis and that you have not exceeded the 100 m (300') working range.
	Semi-automatic Calibration does not work. The LEDs on the Rod Eye 180 are flashing ten times slowly.	The Semi-automatic Calibration procedure could not be completed.  Repeat the procedure. If the procedure is still not successful, contact an authorised service centre.

## Troubleshooting

Problem	Possible Causes	Suggested Solutions
The Rugby does not turn on.	The batteries are low or dead.	Check the batteries and change or charge the batteries if necessary. If the problem continues, return the Rugby to an authorised service centre for service.
The distance of the laser is reduced.	Dirt is reducing the laser output.	Clean the windows of the Rugby and the receiver. If the problem continues, return the Rugby to an authorised service centre for service.
The laser receiver is not working properly.	The Rugby is not rotating. It may be levelling or in H.I.Alert.	Check for proper operation of the Rugby.  Refer to the receiver manual for more information.
	The receiver is out of usable range.	Move closer to the Rugby.
	The batteries of the receiver are low.	Check the low battery symbol on the receiver display. Change the receiver batteries.
The RC800 remote control is not working properly.	The remote control is out of usable range.	For normal operation, the remote control works up to 300 m (1,000').
	The batteries of the remote are low.	Check the Remote Battery LED on the control panel. Change the remote control batteries.
The display is too dark or too light.	The setting of the display brightness is unsuitable.	The brightness for both the Rugby and the remote control can be reset in the menu of the respective device. Refer to "Display Brightness"(Rugby) or to "Display Brightness"(Remote control).
The grade is shown in percent(%) or per mil (‰).	The wrong setting has been selected.	Choose the desired setting in the option menu. ("Display - Percent/Per Mil")
The grade resets to zero each time the laser is turned on.	The wrong setting has been selected.	Choose the desired setting in the option menu. ("Show Grade Settings on Power Up")
The laser stops too often to relevel.	The sensitivity setting may be set to the "fine" setting (Setting 1).	Choose the Sensitivity Setting 2 in the option menu. ("Sensitivity Settings")
	The Tripod may be unstable.	Check your tripod for stability. Tighten all screws. Use sand bags on the legs if necessary.
	The wind is causing the Rugby to move too much.	Shelter the Rugby from the wind. Press the tripod legs more firmly into the ground.

## 13

## Care and Transport

### 13.1

### Transport

---

<b>Transport in the field</b>	When transporting the equipment in the field, always make sure that you <ul style="list-style-type: none"><li>• either carry the product in its original transport container,</li><li>• or carry the tripod with its legs splayed across your shoulder, keeping the attached product upright.</li></ul>
<b>Transport in a road vehicle</b>	Never carry the product loose in a road vehicle, as it can be affected by shock and vibration. Always carry the product in its transport container, original packaging or equivalent and secure it.
<b>Shipping</b>	When transporting the product by rail, air or sea, always use the complete original Leica Geosystems packaging, transport container and cardboard box, or its equivalent, to protect against shock and vibration.
<b>Shipping, transport of batteries</b>	When transporting or shipping batteries, the person responsible for the product must ensure that the applicable national and international rules and regulations are observed. Before transportation or shipping, contact your local passenger or freight transport company.
<b>Field adjustment</b>	Periodically carry out test measurements and perform the field adjustments indicated in the User Manual, particularly after the product has been dropped, stored for long periods or transported.

---

### 13.2

### Storage

---

<b>Product</b>	Respect the temperature limits when storing the equipment, particularly in summer if the equipment is inside a vehicle. Refer to "14 Technical Data" for information about temperature limits.
<b>Field adjustment</b>	After long periods of storage inspect the field adjustment parameters given in this user manual before using the product.
<b>Li-Ion and alkaline batteries</b>	<b>For Li-Ion and alkaline batteries</b> <ul style="list-style-type: none"><li>• Refer to "Technical Data" for information about storage temperature range.</li><li>• Remove batteries from the product and the charger before storing.</li><li>• After storage recharge batteries before using.</li><li>• Protect batteries from damp and wetness. Wet or damp batteries must be dried before storing or use.</li></ul> <b>For Li-Ion batteries</b> <ul style="list-style-type: none"><li>• A storage temperature range of 0°C to +30°C / +32°F to +86°F in a dry environment is recommended to minimize self-discharging of the battery.</li><li>• At the recommended storage temperature range, batteries containing a 30% to 50% charge can be stored for up to one year. After this storage period the batteries must be recharged.</li></ul>

---



## 13.3

## Cleaning and Drying

---

### Product and accessories

- Blow dust off lenses and prisms.
  - Never touch the glass with your fingers.
  - Use only a clean, soft, lint-free cloth for cleaning. If necessary, moisten the cloth with water or pure alcohol. Do not use other liquids; these can attack the polymer components.
- 

### Damp products

Dry the product, the transport container, the foam inserts and the accessories at a temperature not greater than 40°C /104°F and clean them. Remove the battery cover and dry the battery compartment. Do not repack until everything is completely dry. Always close the transport container when using in the field.

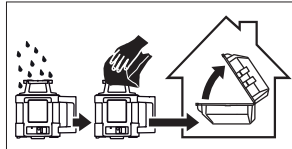

### Cables and plugs

Keep plugs clean and dry. Blow away any dirt lodged in the plugs of the connecting cables.

---

## 14

## Technical Data

### 14.1

### Conformity to National Regulations

#### Conformity to national regulations

- FCC Part 15 (applicable in US)
- Hereby, Leica Geosystems AG, declares that the product Rugby 870/880 is in compliance with the essential requirements and other relevant provisions of Directive 1999/5/EC and other applicable European Directives. The declaration of conformity may be consulted at <http://www.leica-geosystems.com/ce>.



Class 1 equipment according European Directive 1999/5/EC (R&TTE) can be placed on the market and be put into service without restrictions in any EU Member state.

- The conformity for countries with other national regulations not covered by the FCC part 15 or European directive 1999/5/EC has to be approved prior to use and operation.
- Japanese Radio Law and Japanese Telecommunications Business Law Compliance.
  - This device is granted pursuant to the Japanese Radio Law and the Japanese Telecommunications Business Law.
  - This device should not be modified (otherwise the granted designation number will become invalid).

#### Frequency band

2400 - 2483.5 MHz

#### Output power

< 100 mW (e. i. r. p.)

#### Antenna

Rugby 870/880

Chip antenna

Rod Eye 180, Digital RF Receiver

Chip antenna

### 14.2

### General Technical Data of the Laser

#### Operating range

Operating range (diameter):

Rugby 870/880:

1100 m/3600 ft

#### Self-levelling accuracy

Self-levelling accuracy:

±1.5 mm at 30 m (±1/16" at 100 ft)

Self-levelling accuracy is defined at 25°C (77°F)

#### Self-levelling range

Self-levelling range:

±6°

#### Head speed

Head speed:

5, 10 rps

#### Laser dimensions



**Grade Capability** Rugby 870:  $\pm 15\%$  (X-axis)  
 Rugby 880:  $\pm 10\%$  in both axes simultaneously, 15% in one axis with up to 3% in the cross axis

**Weight** Rugby 870/880 weight with battery: 3 kg/6.6 lbs.

**Internal battery**

Type	Operating times* at 20°C
Lithium-Ion (Li-Ion Pack)	50 h
Alkaline (four D-cells)	40 h

\*Operating times are dependent upon environmental conditions.

 Charging the Li-Ion battery pack takes a maximum of five hours.

 Use only high quality alkaline batteries to achieve operating time.

**Environmental specifications**

**Temperature**

Operating temperature	Storage temperature
-20°C to +50°C (-4°F to +122°F)	-40°C to +70°C (-40°F to +158°F)

**Protection against water, dust and sand**

Protection
IPX8 (IEC 60529) / MIL-STD-810G
Dust tight
Protected against continuous immersion in water.

**A100 Lithium-Ion charger**

Type: Li-Ion battery charger  
 Input voltage: 100 V AC-240 V AC, 50 Hz-60 Hz  
 Output voltage: 12 V DC  
 Output current: 3.0 A  
 Polarity: Shaft: negative, Tip: positive

**A800 Lithium-Ion battery pack**

Type: Li-Ion battery pack  
 Input voltage: 12 V DC  
 Input current: 2.5 A  
 Charge time: 5 hours (maximum) at 20°C

## 14.2.1

## RC800 Remote Control

**Operating range** Operating range (diameter): 600 m / 1000 ft

**Batteries** Batteries: Alkaline Two AA-cells  
Battery life (typical usage) 70 hours

### Remote Control dimensions



## 15

## Lifetime Manufacturer's Warranty

### Description

#### Lifetime Manufacturer's Warranty

Warranty coverage for the entire usage time of the product under PROTECT according to Leica Geosystems International Limited Warranty and PROTECT General Terms & Conditions set out under [www.leica-geosystems.com/protect](http://www.leica-geosystems.com/protect). Free charge repair or replacement of all products or any parts under PROTECT that suffer defects as a result of faults in materials or manufacturing.

#### 5 Years No Costs

Additional services should the product under PROTECT become defective and require servicing under normal conditions of use, as described in the user manual, at no additional charge.

To receive the "5 years no cost" period, the product must be registered at [www.leica-geosystems.com/registration](http://www.leica-geosystems.com/registration) within 8 weeks of the purchase date. If the product is not registered, a "Two years no cost" period applies.

### Description

#### Two Year Knockdown Warranty

In addition to the lifetime manufacturer's warranty and the "No Cost" period for additional services, the internal self-levelling system of the product under PROTECT is covered. Should any accident or knockdown occur within two years of the purchase date, all repairs to the internal self-levelling assembly will be covered under PROTECT General Terms & Conditions.

### Accessories for power supply

#### A100 - Li-Ion Charger (790417)

The A100 Li-Ion charger comes complete with four separate AC adaptors.

#### A130 - 12 Volt Battery Cable (790418)

The A130 12 volt battery cable connects the Rugby to a standard 12 volt automotive battery as a backup for the battery of the unit. It is only usable with the rechargeable battery pack. Length: 4 metres/13 feet.

#### A140 - Car Adapter Cable (797750)

The A140 car adapter cable connects the Rugby to a standard automotive accessory jack as a backup for the battery of the unit or to charge in a vehicle. It is only usable with a rechargeable battery pack. Length: 2 metres/6.5 feet.

#### A150 - Alkaline Battery Pack (790419)

The A150 alkaline battery pack is included as part of the standard alkaline package. It can also be purchased separately to be used as a backup for rechargeable models. Batteries required: Four D-cell type alkaline.

#### A170 - Solar Panel Kit (807479)

The A170 solar panel kit runs and charges the Rugby. It is usable only with a rechargeable battery pack. The A170 solar panel comes complete with its own storage bag that can be attached directly to the Rugby carrying case.

#### A800 - Li-Ion Battery Pack (790416)

The A800 Li-Ion battery pack is included as part of the standard rechargeable package. It can also be purchased separately as an upgrade to the alkaline battery pack. To complete the Li-Ion battery solution, it is also necessary to purchase the A100, Li-Ion battery charger.

#### A260 - Scope and Mount (739870)

The A260 Scope and Mount attaches magnetically to the top of the Rugby 870/880 and provides a repeatable solution for axis alignment and second day setups. The scope must be initially aligned to individual units.



# Index

---

<b>A</b>	
Accessories .....	69
Accuracy	
Self-levelling .....	66
Accuracy Adjustment .....	54
Adjust	
Level Accuracy .....	55
Vertical Accuracy .....	57
Alignment	
Axes .....	22
Axes, precise .....	22
Antenna	
Technical Data .....	66
Applications	
Checking Grades .....	43
Entering Grades .....	44
Setting Forms .....	42
Smart Target .....	45
Smart Target Lock .....	46
Axis Identification .....	21
<b>B</b>	
Batteries	
Charging, first-time use .....	50
Operation, Discharging .....	50
Battery	
Change alkaline batteries .....	53
Change Li-Ion battery pack .....	52
Charge .....	51
Technical data .....	67
Battery Charger	
Technical data .....	67
Battery Pack	
Technical data .....	67
<b>C</b>	
Control Panel .....	17
Conversion	
Slope - Percent of Grade .....	21
<b>D</b>	
Definition of Use .....	7
Description of the system .....	14
Dimensions	
Of laser .....	66
Of Remote Control .....	68
Documentation .....	2
Dual Receiver Setups .....	49
<b>E</b>	
Environmental specifications	
Laser .....	67
<b>F</b>	
FCC Statement .....	12
Frequency Band	
Rugby .....	66
<b>I</b>	
Instrument	
Main Display .....	18, 18
Technical Data .....	66
Turn on and off .....	17
Intended use .....	7
<b>L</b>	
Laser	
Classification .....	10
Dimensions .....	66
Grade Capability .....	67
Laser Classification	
Rugby 840 .....	10
Level Accuracy	
Adjust .....	55
Check .....	54
Li-Ion battery .....	67
Storage .....	64
<b>M</b>	
Menu	
Remote Control .....	41
Rugby .....	30
<b>O</b>	
Operating range .....	66
Output Power	
Rugby .....	66
<b>P</b>	
Pairing	
Remote Control with Rugby .....	25
Rod Eye 180 .....	29

<b>R</b>	
Range	
Self-levelling .....	66
Receiver	
Pairing .....	29
Remote Control	
Dimensions .....	68
Responsibilities .....	7
Rod Eye	
Instrument components .....	27
Rod Eye 160	
Buttons .....	27
Instrument components .....	27
Rod Eye 180	
Automatic Axis Alignment .....	47
Axis Alignment plus Smart Target Lock .....	49
Buttons .....	28
Instrument components .....	28
Smart Target Lock .....	46
Smart Targeting .....	45
Rod Eye Receiver .....	27, 27, 27, 28
Rotation speed .....	66
<b>S</b>	
Safety Directions .....	6
Semi-Automatic Calibration .....	58
Setup	
Dual Receivers .....	49
Instrument on tripod .....	16
Specifications, environmental	
Instrument .....	67
<b>T</b>	
Temperature	
Laser	
Operating .....	67
Storage .....	67
Temperature, charging internal battery .....	50
Troubleshooting .....	63
<b>U</b>	
User Manual	
Validity of .....	2
<b>V</b>	
Vertical Accuracy	
Adjust .....	57
<b>W</b>	
Warranty .....	68
Weight	
Instrument .....	67

**799894-1.0.0en**

Original text

Published in Switzerland

© 2014 Leica Geosystems AG, Heerbrugg, Switzerland

**Leica Geosystems AG**

Heinrich-Wild-Strasse

CH-9435 Heerbrugg

Switzerland

Phone +41 71 727 31 31

[www.leica-geosystems.com](http://www.leica-geosystems.com)

- when it has to be **right**

**Leica**  
Geosystems