

Method for Assembly of BoSS Tower Linked with Beam Units (Addendum to standard user guide)

YOUNGMAN

INNOVATIVE WORK AT HEIGHT SOLUTIONS

1 Start by assembling the base of the first tower exactly as described in the current BoSS user guide, ensure this structure is level and square, the ladder side of the tower is on the side the beams will be fitted.

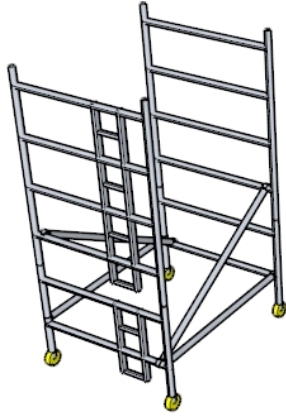

2 Temporarily attach 2 no beam unit handrail braces on the uprights resting on the first rung in line with these frames. These braces to be the same length as the beam units, this will correctly space the towers to enable fitting of the beams at working platform level.

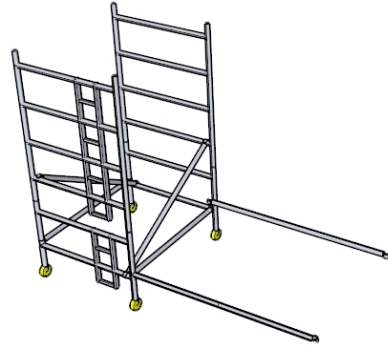

3 Assemble the base of the second tower as Step 1 again the ladder side of the tower should be on the inside of the beam and attach to the opposite ends of the beam unit handrail braces, now forming 3 rectangles linked in parallel with one another. At this stage it is very important that the two tower base units are exactly level with each other by using a level on the spacing braces.

It is well worth spending a little extra time carrying out the levelling operation to ensure that the whole structure is perfectly level and square as this will save time later in the build.

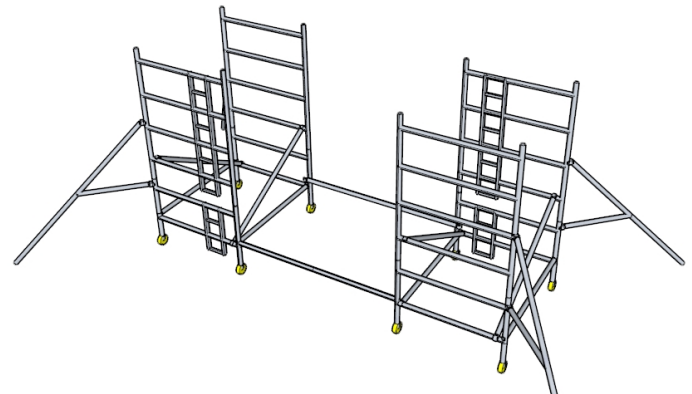

4 Once the base is level continue building the two towers to the required platform height using the 3T method, following the BoSS user guide taking care to fit the appropriate stabilizers when required.

The ladder side of each tower should be on the inside of the structure, this will allow the operatives to install the beam units from the intermediate deck level below the work platform in the next stage. Do not fit the toe boards yet.



Method for Assembly of BoSS Tower Linked with Beam Units (Addendum to standard user guide)

YOUNGMAN

INNOVATIVE WORK AT HEIGHT SOLUTIONS

5 At this stage of the assembly a minimum of 3 operatives will be required, one on each tower and one at ground level. The operatives on the towers should position themselves on the trap deck below the working platform level.

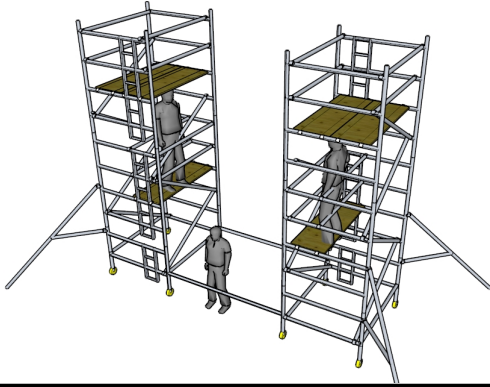

6 The beam units should be passed up and fitted one each side between the two towers resting on the rung below the working platform level. Brace locking devices to face outwards. Ensure that the top tube of the beam unit is at the same level as the frame rung on which the working platforms are fitted.

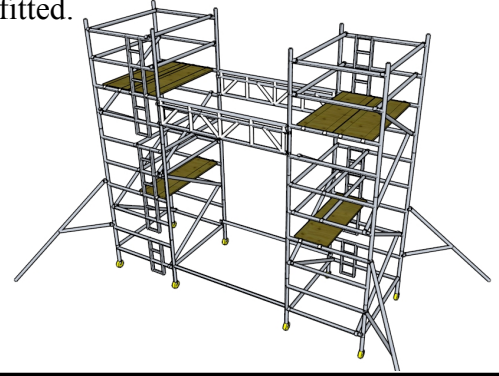

7 Fit two beam unit handrail braces on rungs one and two above the beams on one side, and move the two beam unit handrail braces from the base and reposition on the opposite side of the structure to the brace's just fitted.

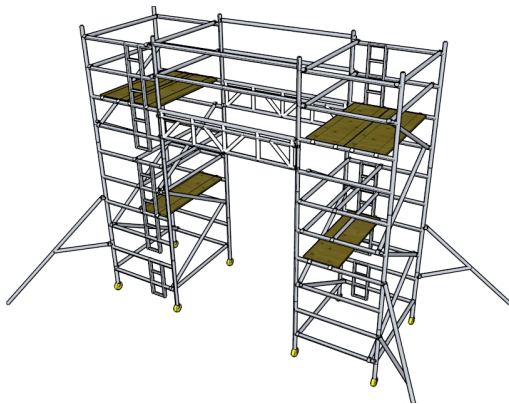

8 Working from 1 tower fit an extra pair of horizontal braces to suit the size of tower being used, position on the upper and lower beam unit handrail braces to the offside of the deck resting on the beams. This will provide double handrail protection on the beam unit platform as decks are positioned

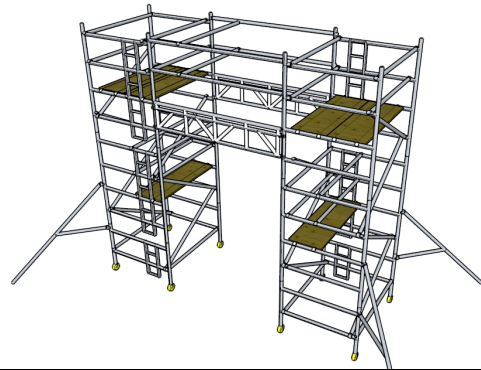

9 Working from one tower slide an appropriate length fixed platform under the tower side handrail to rest on the beam units, approx 150mm gap between the tower deck and the deck on the beams

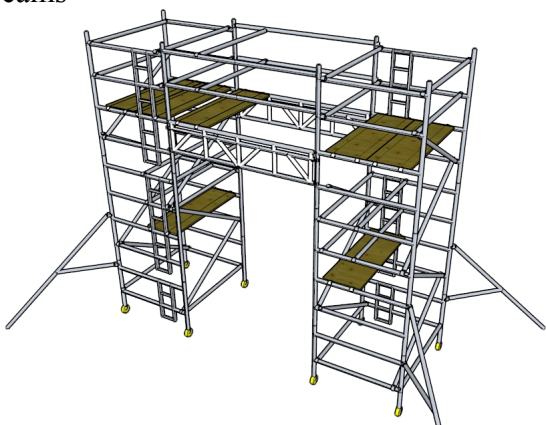

10 Fit a beam unit infill deck to bridge the gap between the tower deck and the beam unit deck, some slight adjustment may be necessary to ensure a snug fit.

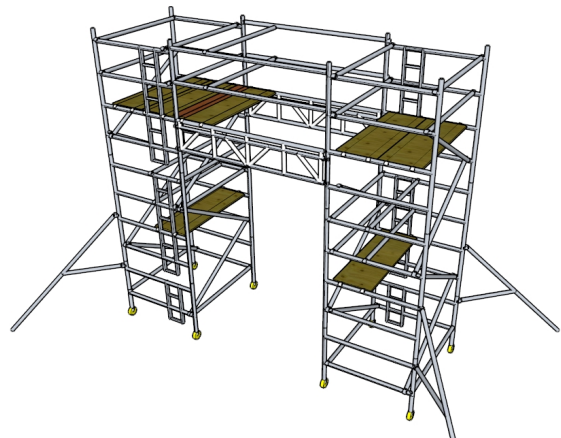

Method for Assembly of BoSS Tower Linked with Beam Units (Addendum to standard user guide)

YOUNGMAN

INNOVATIVE WORK AT HEIGHT SOLUTIONS

11 Repeat Step 9 for either three, four or five decks depending on the length of beam unit used.

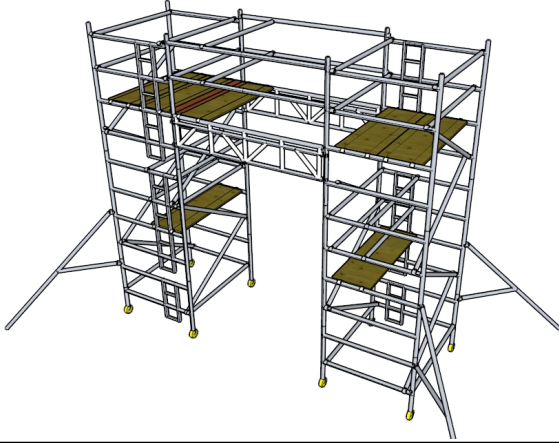

12 When all the decks are positioned on the beams fit the second beam unit infill deck to close the gap between the beam decks and the tower deck, some slight adjustment may be necessary to ensure a snug fit.

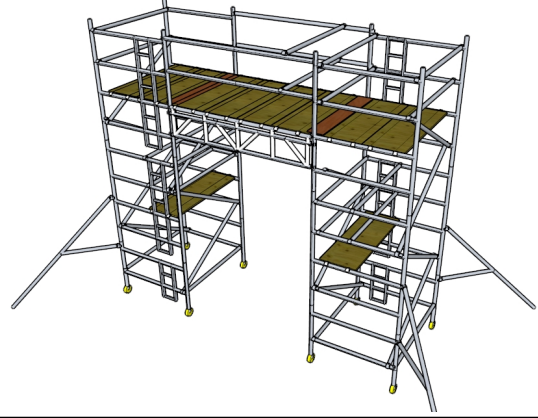

13 Remove the inside handrail braces from the second tower to form an uninterrupted platform area.

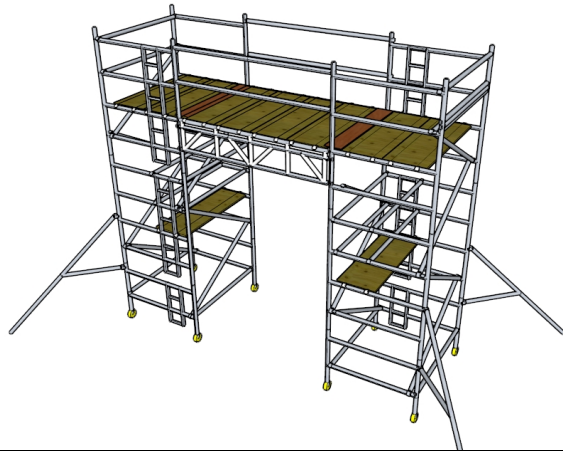

14 Fit the supplied toe board kit to completely surround the platform area to comply with legal requirement
The lower beam unit handrail braces can be removed if required

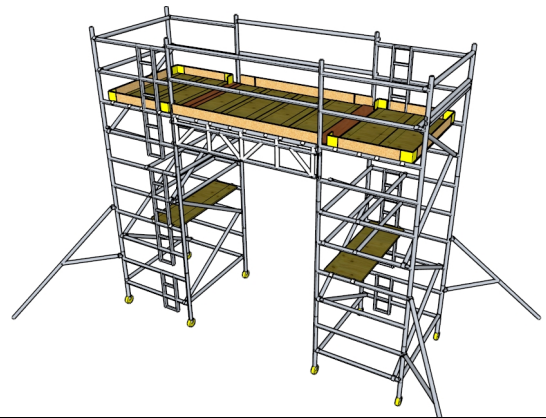

Notes

This type of structure must be erected by operatives with a PASMA certificate & Product Specific Training
Never stand or work on an unprotected platform
Do not exceed the SWL of any platform or tower structure as a whole
(Max. SWL on Beam unit structure 150kg)

BOSS Beam Unit & Decking Layouts

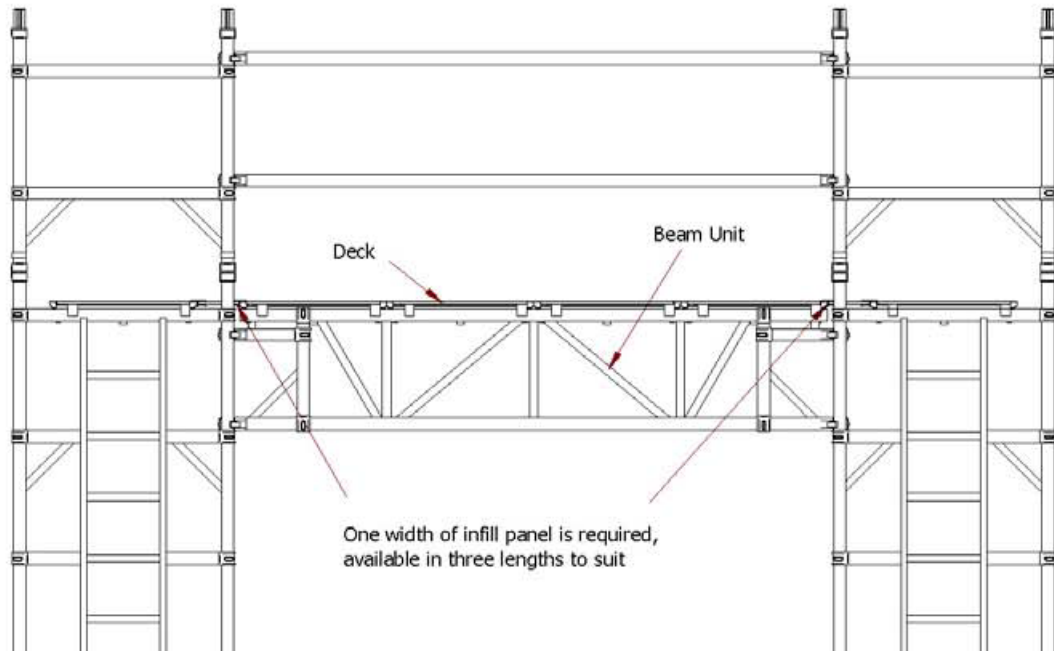

BOSS Detail of Fitting for Beam Unit Toeboard

