

UNIKA

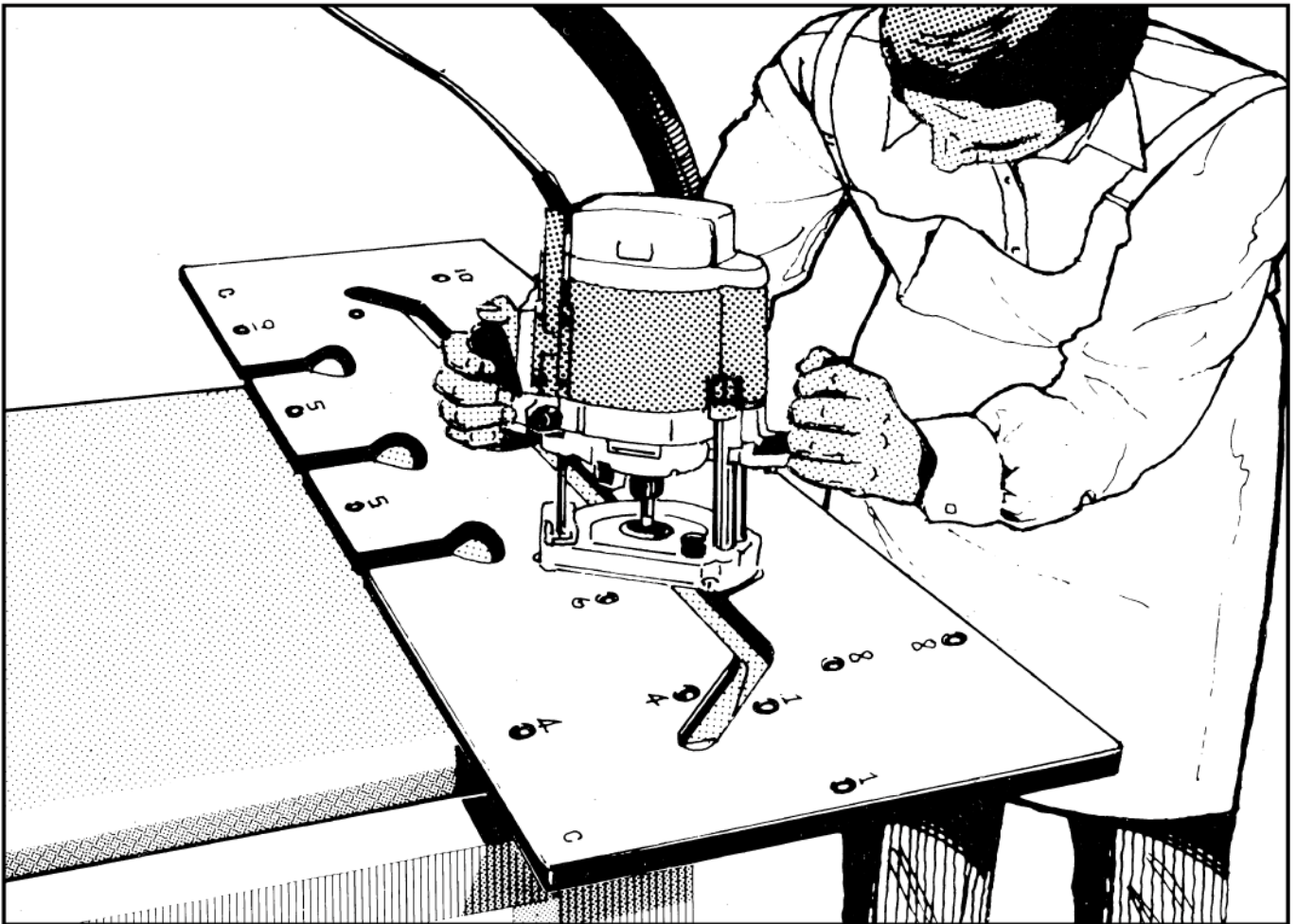

Supa Jig



Unika Color Products Ltd.

Unika House, New York Way,
New York Industrial Park,
Newcastle Upon Tyne, NE27 0QF

Tel: +44 (0) 191 2590033 Fax: +44 (0) 191 2574525

UNIKA SUPAJIG INSTRUCTIONS

1.00 General Information

1.01 Introduction

Thank you for purchasing the Unika SupaJig: the most advanced design of worktop jig available. Your jig will allow you to complete

a range of cuts and incorporates other design features to use the jig as a straight edge and as a radius guide.

SupaJig also has a unique quick reference guide to the various types of cut engraved on each face and a comprehensive system of labels to allow easy use without constant reference to the written instructions.

1.02 What you will need

In addition to the jig and the 5 pegs provided, you require:

- A plunge action router of at least 1500w rating
- A sharp 12.7mm diameter cutter, 50mm length blade - Titman code H122
- A 30mm guide bush
- Two quick release or G-Clamps

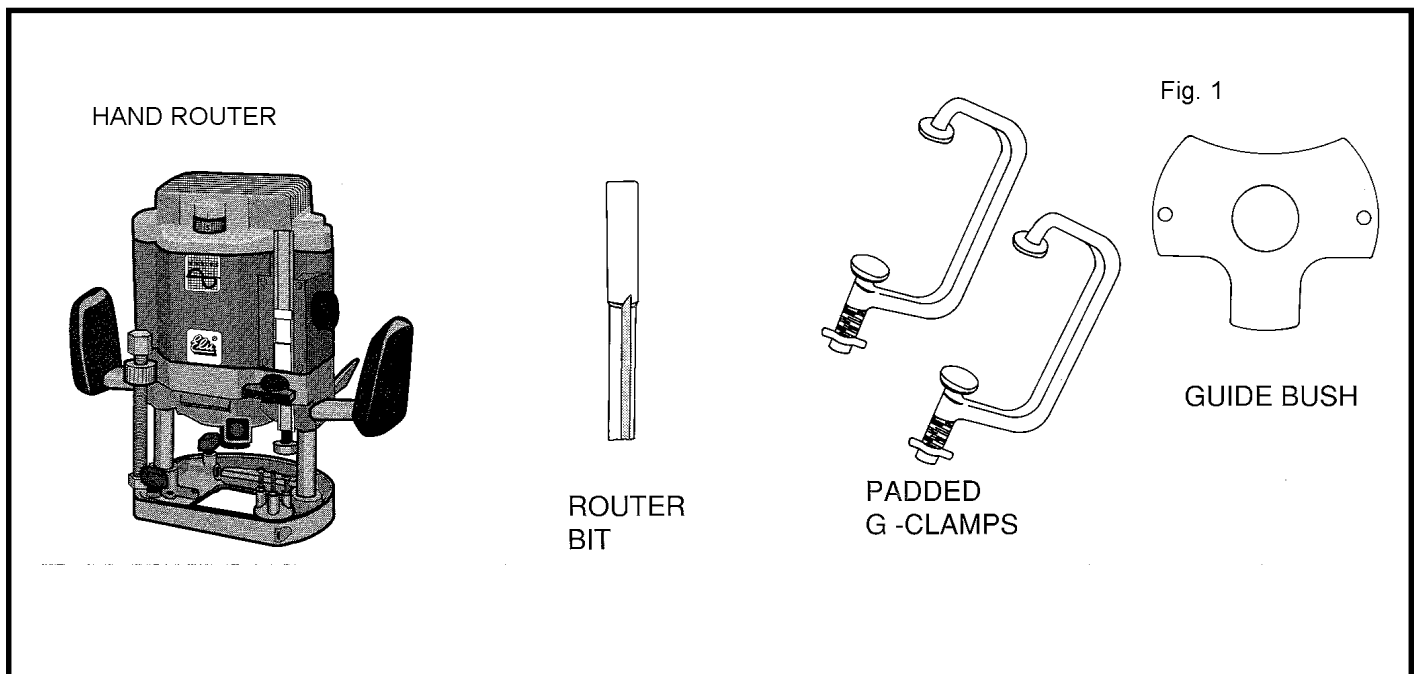

1.03 Before you start

Please take some time to read through these instructions *and always practise on offcuts until you achieve a satisfactory result.* Please observe all relevant safety requirements for the use of

routers and never lift the router away from the jig until the cutter has stopped rotating and is fully retracted.

1.04 How the jig works

Depending on the particular cut required, the pegs are placed in the holes indicated in the instructions. The jig is offered up to the worktop and clamped in position. The jig is then used to guide the router. Most cuts are made in stages with the waste being progressively removed. Followed by a final stroke which provides a perfectly finished edge.

1.05 Conventions and important points

- ***All*** references to left and right hand joints in these instructions use the convention described in the diagram engraved on each face of the jig.
- Always use a sharp cutter and ensure the guide bush is firmly attached to the base plate.
- Always work from left to right *never the other way round*.
- Make sure the pegs are well seated and are not proud of the surface of the jig.
- Wherever you see letters in *italics* on the jig (e.g. *LF*), this is a reminder that this cut is performed with the worktop face down.
- The holes surrounded by a square indicate that a peg should *not* be inserted from this side when performing any of the cuts.
- When working with the centre slot the side *nearest* you is *always* used *first* for the waste removal followed by the side *furthest* from you for the finished edge.
- When clamping in position check the pegs are still in contact with the worktop as certain types of clamp can cause the jig to creep out of position if over tightened.
- The guide bush should be set to a depth of 11mm to allow maximum contact with the jig without fouling the worktop surface.
- Take care to ensure the router remains absolutely perpendicular when performing all cuts; this is particularly important when performing cuts with the worktop face down.
- The bolt slots will accommodate most common patterns of 150mm joining bolt. If in doubt use Unika Bolts.
- When making many of the cuts you may find it more convenient to remove larger pieces of waste with a jigsaw prior to making the router cuts. This is particularly relevant when you are unable to support waste which would fall away in the cutting process.

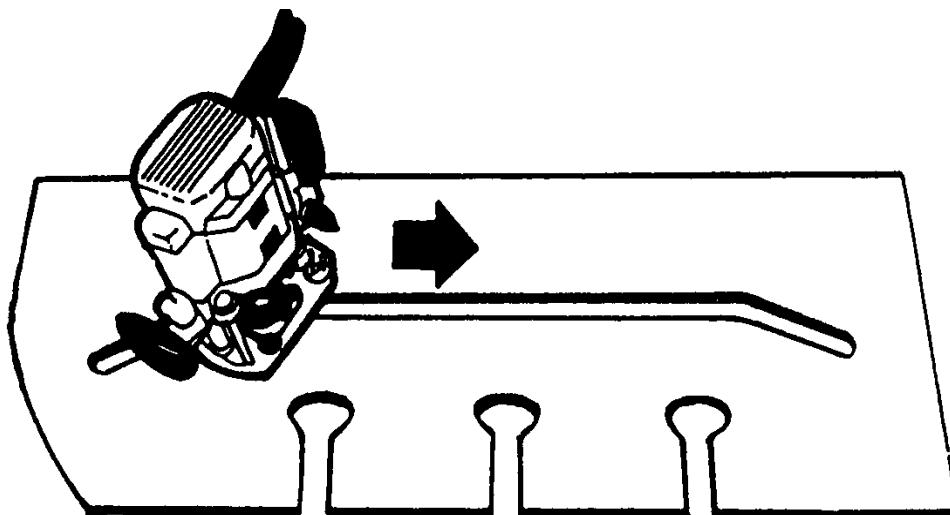

It is important that you work the router from left to right. To work the router right to left means working against the cutter's direction, which will cause the router to travel away from you and may damage the jig or even cause injury.

2.00 90° Corner Joints

2.01 90° Corner-Right-hand female cut

With the jig logo side up, place a peg in the length stop hole which matches the width of *male section* of worktop you wish to set in. Place pegs in all holes marked RF+LF to the left of the length stop peg. With the worktop face-up offer the jig against the post form edge and rest the length stop peg against the right-hand edge of the worktop. Ensure all pegs are touching the worktop and clamp in position then check again.

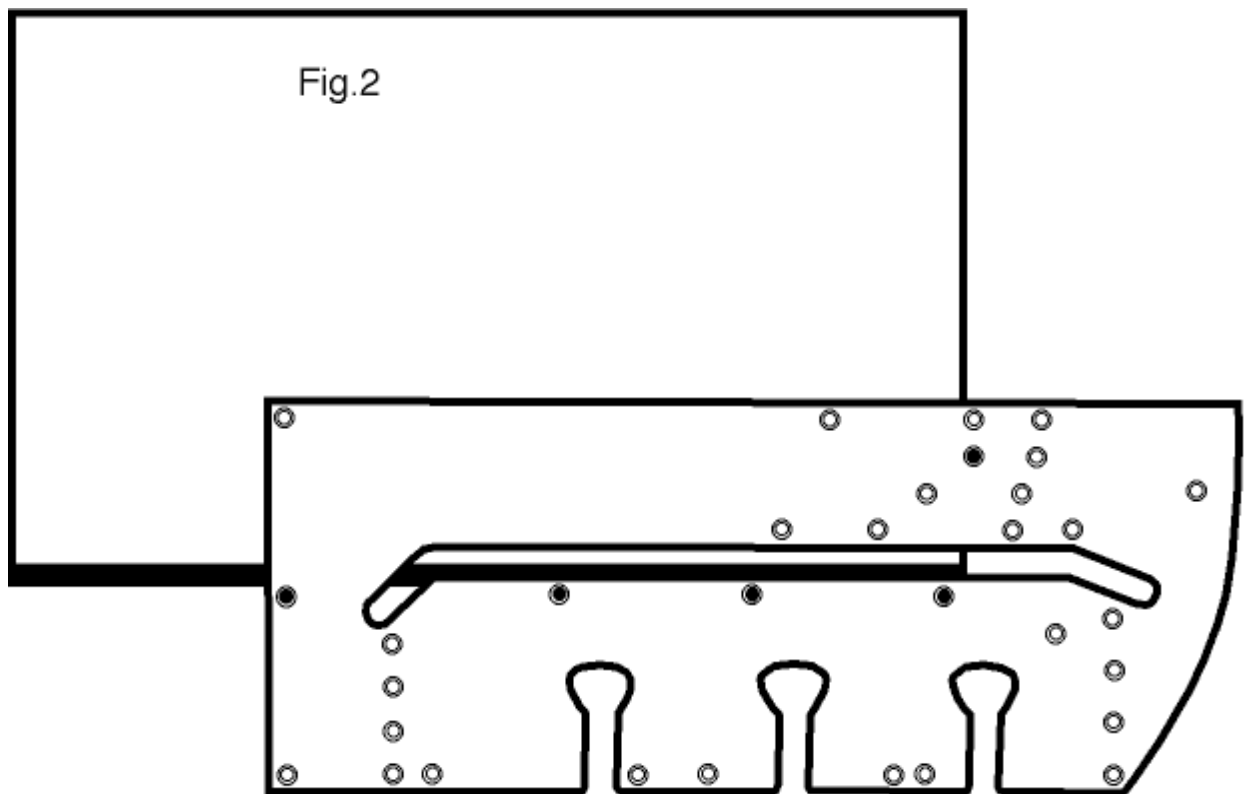

Position the router in extreme bottom left-hand point of the centre slot. Set the cutting depth to 10-15mm and start the router. Pass the router steadily along the centre slot using the side of the slot *nearest* you to guide the router. Repeat this process increasing the depth of cut by 10-15mm for each pass until the post-form edge has been removed. With the cutter set to maximum depth but this time using the side of the slot *furthest* from you to guide the router, make one final pass which will remove approximately 1mm leaving a perfectly cut edge.

Note These instructions set up the jig to cut 90° corners. If you wish to allow for slightly out of square walls, remove 1 or more of the RF+LF pegs and adjust the angle of the jig against the post-form edge. More substantial movements out of square require a corresponding adjustment

when cutting the male component. You should be fully conversant with the usual functions of the jig before attempting this type of adjustment.

2.02 90° Corner - Left-hand female cut

Place the worktop face-down, post-form edge towards you and follow the instructions as per 2.01.

2.03 Measuring & cutting the male component to length

The diagram engraved on each face of the jig depicts the optimum layout for worktops fitted to 3 walls. This arrangement is easy to measure and leaves the greatest margin to recover from mis-measures. If, however you are forced to arrange the worktops as per fig 4, you should carefully read the following instructions. Please exercise extreme caution when cutting the centre section of fig 4!

Your jig will inset one worktop 35mm into the post-form edge of the other. When measuring up an allowance must be made for this on the male section of the worktop. Refer to the two diagrams below to help calculate your measurements *fig. 3 & 4*.

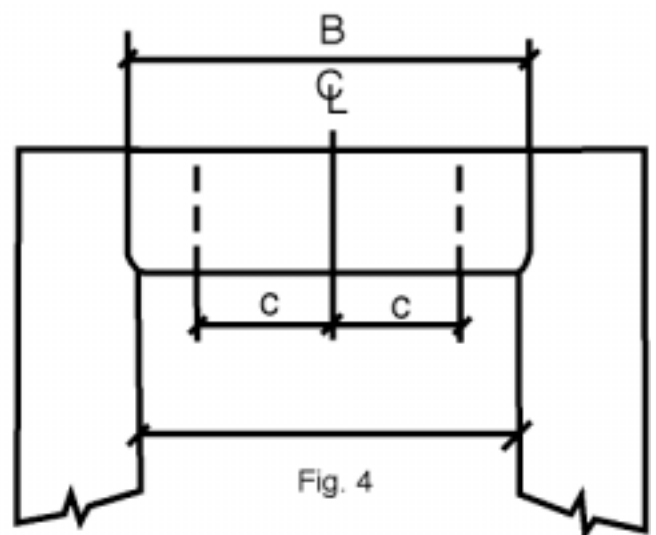
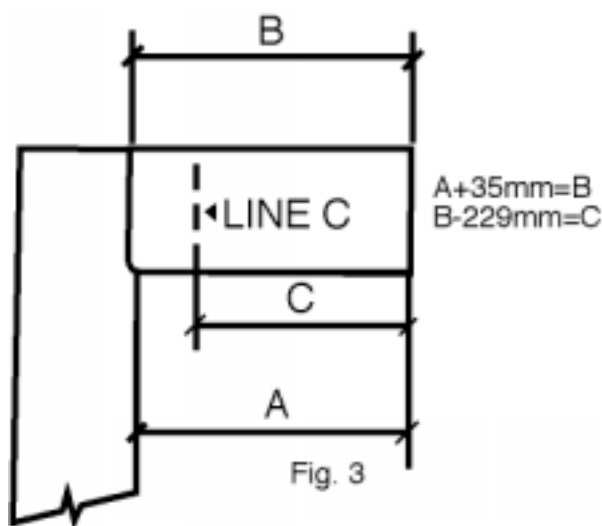

2.04 90° Corner - Right-hand male cut

Place the worktop face down. Turn the jig logo side down and place 4 pegs in the holes marked *RM+LM* and offer firmly up against the post-form edge *fig. 5*. Using the measurements calculated in the above section, mark line C on the worktop in pencil and align the bottom edge of the jig with this position. Clamp in position and check again to ensure all pegs are in contact with the post-form edge and the jig is in position.

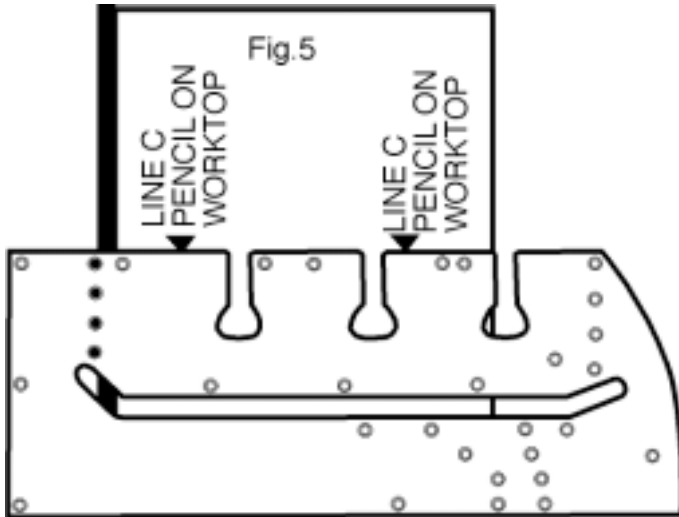

Position the router in extreme top left-hand point of the centre slot. Set the cutting depth to 10-15mm and start the router. Pass the router steadily along the centre slot using the side of the slot *nearest* you to guide the router. Repeat this process increasing the depth of cut by 10-15mm for each pass until the waste has been removed. With the cutter set to maximum depth but this time using the side of the slot *furthest* from you to guide the router, make one final pass which will remove approximately 1mm, leaving a perfectly cut edge.

2.05 90° Corner - Left-hand male cut

Place the worktop *face up* and follow the instructions in 2.04.

2.06 Joining bolt slots in 90° Females

Place the worktop *face down*. The *jig* should be *logo side down* right-hand females (RF) or *logo side up* for left-hand females (LF). Place 4 pegs in the holes marked B.

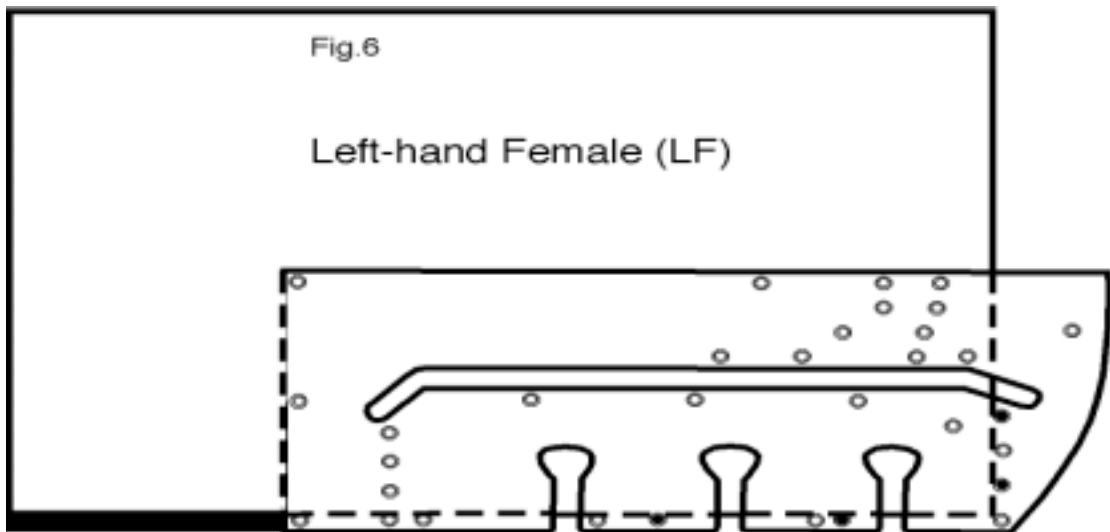

Offer the jig up to the worktop and clamp into position. Set your plunging depth to about 20mm. You should ensure this is sufficient to accommodate your joining bolt. Now use each mushroom shaped recess to guide the router. Working clockwise around the slot, remove all the waste. *Note;* worktop widths 400-550mm will only accommodate 2 slots.

2.07 Joining bolt slots in 90° Males

Place the worktop *face down*. The jig should be logo side up for right-hand males (RM) {illustrated} or log side down for left-hand males (LM). Place 4 pegs in the holes marked B. Follow the routing instructions in 2.06

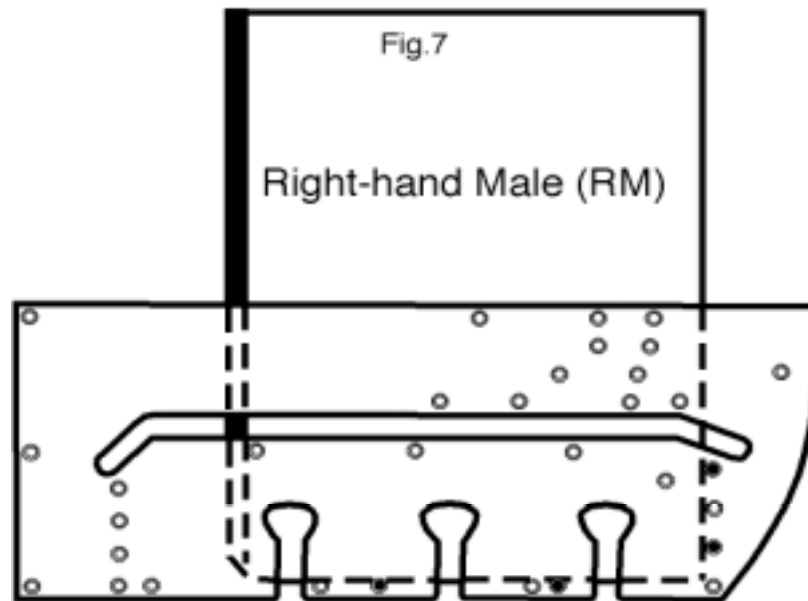

2.08 Connecting the worktops

Carefully manoeuvre the worktops into position taking great care not to allow the routed face of each component to damage the other. Connect using 150mm joining bolts and ColorFill®.

3.00 Corner cooking solution joints

The following instructions are based on 570mm deep carcasses and 600mm wide tops. The resulting corner will accommodate a 600mm wide corner unit. The minimum length of worktop required for the corner piece is 1600mm. The inset is 13mm.

Fig. 8

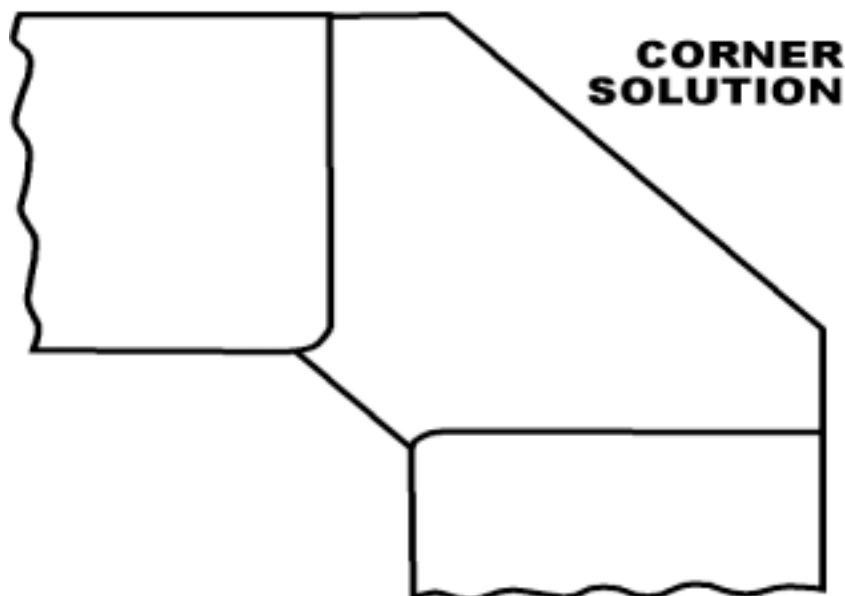

3.01 Corner Cooking Solution - Right-hand Femal (CFR)

Place the worktop centre piece face-up; mark a centre line in the middle and mark two lines 640mm either side on the back edge of the worktop. *Tip:* the jig used in straight edge mode can help greatly with your marking out on this type of corner, see 4.01.

With the jig logo side down, place 3 pegs in the holes marked CFR+CFL. Offer the jig up against the post-form edge and align the top edge of the jig with the right-hand 640mm mark. Clamp in position and check again for correct alignment. Follow the cutting instructions for 90° Females.

When complete remove the jig. Measure 600mm from the post-form edge as per fig 10 and accurately remove this section using a saw.

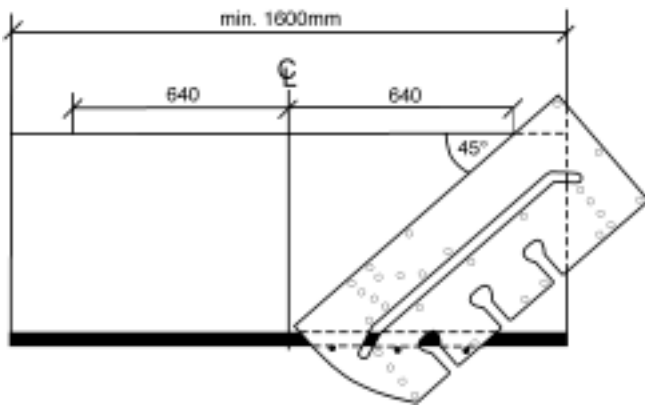

Fig. 9

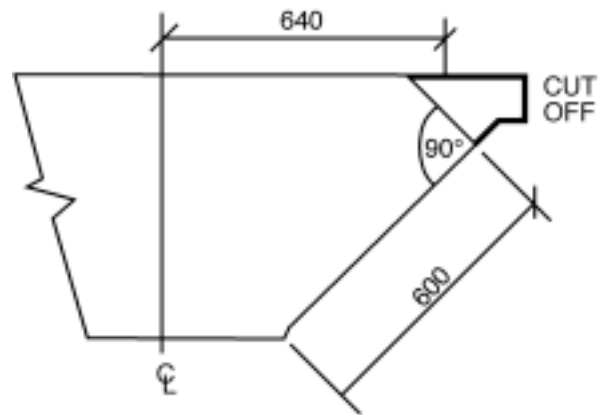

Fig. 10

3.02 Corner Cooking Solution - Left-hand Female (CFL)

Turn the worktop centre piece face down and follow the instructions in 3.01.

3.03 Corner Cooking Solution - Right-hand Male (CMR)

Place the worktop face down. With the jig logo-side up place 4 pegs in the holes labelled CMR+CML fig 11. Follow the routing instructions in 2.04.

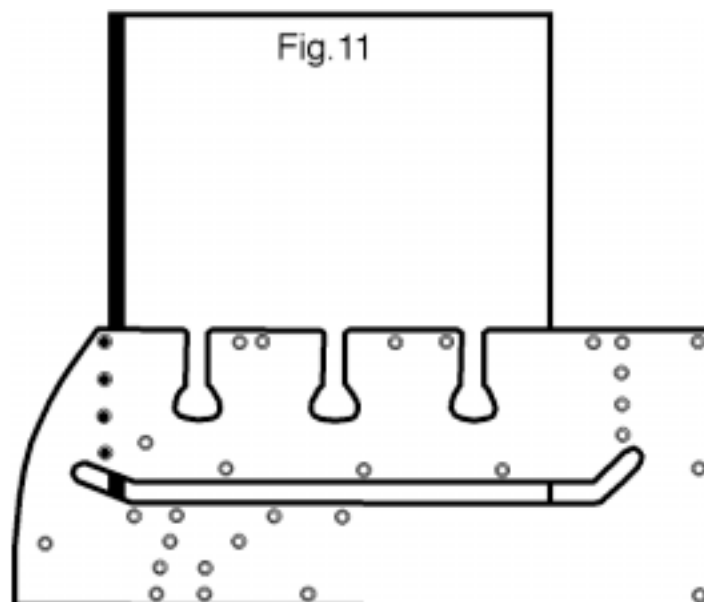

3.04 Corner Cooking Solution - Left-hand Male (CML)

Place the worktop face up and follow instructions as per 3.03

3.05 Corner Cooking Solution - Female bolt slots

Place the centre piece face down. The jig should be logo side up for left-hand females (CFL) fig 12 or logo side down for right-hand females (CFR) *not shown*. Place 4 pegs in the holes marked *B* and offer the jig up against the cut face as per the diagram below. Follow the routing instructions as per 2.06.

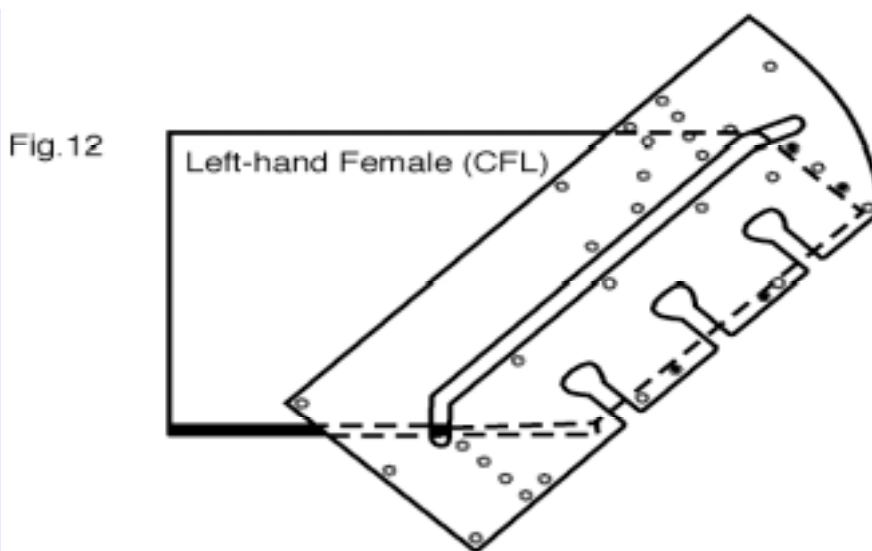

3.05 Corner Cooking Solutions - Male bolt slots

Follow the instructions as per 2.07

4.00 Other functions of your jig

4.01 Straight edge mode

Your jig can help you mark off, quickly and accurately, common angles. It can also act as a guide for various types of power tool.

To use your jig in this mode place 1 peg in the hole marked SE and another in one of the angle holes arranged along the bottom edge 90°, 67.5°, 45° or 30°. Offer the jig up against the work. Clamp in position and use the top edge as the straight edge.

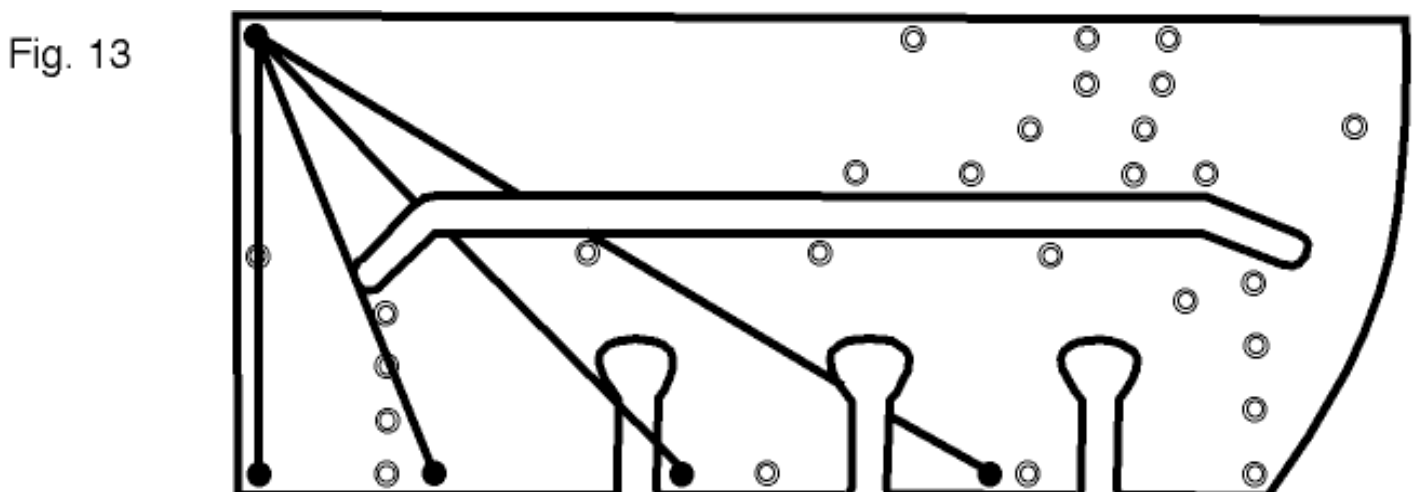

4.02 Breakfast bar radius end mode

The jig can be used as a guide when adding a radius to the end of a worktop or panel. You may use any of the 3 horizontal arrays of holes indicated in fig 14 for the pegs. Mark out in pencil using the radius edge as a guide and remove the waste with a jigsaw. Set the jig up again, clamp in position and use the router to remove no more than one quarter of the cutter's diameter to leave a perfectly finished edge. *Extreme caution should be exercised when attempting this type of cut - your router can easily tip causing damage or injury.*

Fig. 14

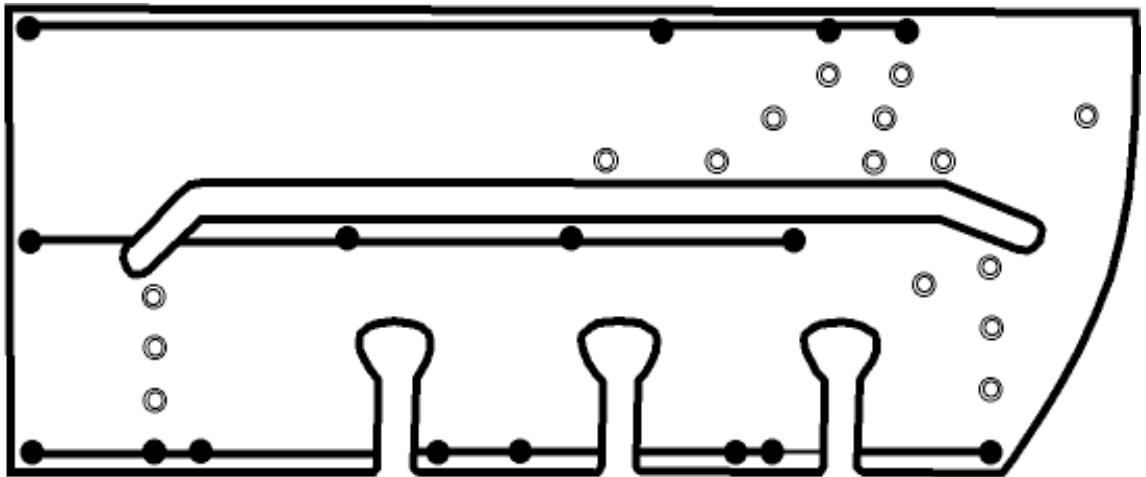

5.00 Troubleshooting Guide

From listening to Kitchen Fitters and Carpenters over the years we have compiled this guide to help you overcome the more common faults encountered. Used correctly, your jig will give perfect results every time.

Problem	Probable Cause	Remedy
Poor finish on male/female joint faces.	Incomplete routing process.	Ensure final stroke against <i>far</i> edge of centre slot is performed.
Sharp angle near post-form edge on male/female	Incomplete routing process.	Ensure final stroke against <i>far</i> edge is performed.
Good finish but male & female don't match up.	Incorrect size of cutter and/or guide bush.	Ensure 12.7mm cutter and 30mm guide bush - <i>nothing else is suitable.</i>
Inconsistent results - wandering edges.	Loose guide bush.	Ensure guide bush is firmly attached to the router base.
Irregular gaps on RH male and/or LH female face.	Poor router control.	Ensure the cutter remains absolutely perpendicular on these cuts.

© Unika Color Products Ltd. 1997.