

# MASTER®

**IT - Generatore d'aria Calda a gas**  
**GB - "LPG" Hot air generator**  
**DE - Mobiles Gasheizgerät**  
**ES - Generador de aire caliente**  
**FR - Appareils de chauffage au gaz**  
**NL - Varwarmingstoestellen op gas**  
**PT - Gerador de ar quente**  
**DK - Luftpvarmer indretning**  
**SV - Varmluftsaggregat**  
**FI - Ilmanlämmityslaite**  
**NO - Luftvarmeapparat**

**Libretto uso e manutenzione - Operation and maintenance manual - Bedienungsanweisung - Manual del propietario - Manuel de L'utilisateur - Handleiding - Manual de instruções e de manutenção - Drift- og vedlikeholdelse håndbogen - Drifts och Uppehålls - Handbok - Käyttäjän ja huoltajan käsikirja - Handbok om bruk og vedlikehold**

  
**DVGW**





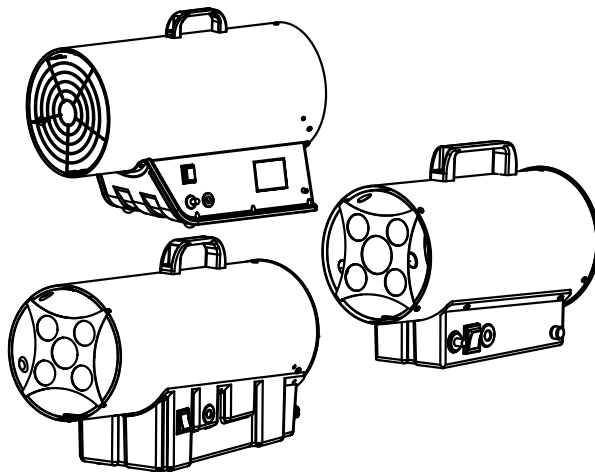



4160.079  
Edition 10  
Rev. 14



 0085

**BLP 10 kW M**  
**BLP 14 kW M**  
**BLP 15 kW M**  
**BLP 25 kW M**  
**BLP 30 kW M**  
**BLP 53 kW M**  
**BLP 73 kW M**

**BLP 25 kW M DV**  
**BLP 30 kW M DV**  
**BLP 53 kW M DV**  
**BLP 73 kW M DV**

MODEL	10 kW M	14 kW M	15 kW M	25 kW M 25 kW M DV	30 kW M 30 kW M DV	53 kW M 53 kW M DV	73 kW M 73 kW M DV
	220/240 V - 50 Hz 0,19 A - 0,029 kW	220/240 V - 50 Hz 0,19 A - 0,029 kW	220/240 V - 50 Hz 0,19 A - 0,029 kW	220/240 V - 50 Hz 110/240 V - 50 Hz* 0,36 A - 0,080 kW	220/240 V - 50 Hz 110/240 V - 50 Hz* 0,36 A - 0,080 kW	220/240 V - 50 Hz 110/240 V - 50 Hz* 0,40 A - 0,103 kW	220/240 V - 50 Hz 110/240 V - 50 Hz* 1 A - 0,188 kW
 <b>MAX (G31-G30)</b>	10 kW / 10,5 kW	15 kW / 16 kW	15 kW / 16 kW	30 kW / 33 kW	30 kW / 33 kW	52 kW	69 kW
 <b>MIN (G31-G30)</b>			11 kW		16 kW	36 kW	49 kW
 <b>(G31-G30)</b>	0,757 kg/h / 0,764 kg/h	1,07 kg/h / 1,16 kg/h	1,07 kg/h / 1,16 kg/h	2,14 kg/h / 2,4 kg/h	2,14 kg/h / 2,4 kg/h	3,78 kg/h	5,02 kg/h
	I <sub>3</sub> B/P						
	300 m <sup>3</sup> /h	300 m <sup>3</sup> /h	300 m <sup>3</sup> /h	1.000 m <sup>3</sup> /h	1.000 m <sup>3</sup> /h	1.450 m <sup>3</sup> /h	2.300 m <sup>3</sup> /h
<b>IP</b>	IP 44						
	0,3 bar	0,7 bar	0,7 bar	1,5 bar	1,5 bar	0,75±1,5 bar	0,75±1,5 bar
<b>1,5m Δ T</b>	< 70° C						

\*= dual voltage version

## DESCRIPTION

This hot air heater is liquid propane gas fired. It is characterized by the total use of the calorific power of the fuel, due to the thermal exchange between the air and the combustion products. The machine complies with EN 1596.

## WARNINGS

- As this machine needs an adequate change of air, it must be used only in the open air or rooms with an assured and continuous change of air. For installation they are valid the national norms in force, included technical norms and fire and accident-prevention regulations.
- The appliance must be used only as hot air generator or fan, following precisely these instructions.
- It is very dangerous and absolutely forbidden use the appliance in "Basements" or underground.
- NOT TO BE USED FOR HEATING OF HABITABLE AREAS OF DOMESTIC PREMISES. FOR USE IN PUBLIC BUILDINGS, REFER TO NATIONAL REGULATIONS.
- In case of gas smell, there could be dangerous leaks. Turn off immediately the appliance, close the cylinder and cut off the plug. Than call the technical assistance.
- When the appliance is stored or not in use, be sure that the flexible hose will not be damaged (plied, bent or twisted).
- Place the gas cylinder in a protected position behind the appliance. Make sure that no objects obstruct the fan air intake.

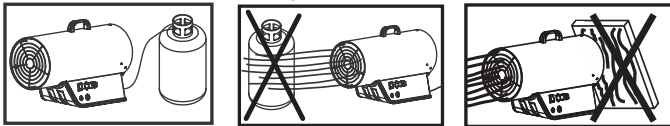

- Connect to electrical mains equipped with a "life-saver" switch.
- Never, for any reason, reduce the size of the air outlet opening.
- Safety distances: 2 metres from walls or objects.
- The mobile generators may be used only on fire-proof floors.
- Do not use the generator in rooms containing explosive powders, gas fumes, liquid fuel or inflammable material (cloth, paper, wood, fuels, etc.).
- Any maintenance or internal cleaning jobs may be performed only by specialised personnel authorised by the manufacturer.
- If the appliance cannot be left in a safe condition, it must be made unserviceable (e.g. seal the gas inlet point and remove the power plug).
- If the application does not ignite or if ignition is faulty, before making a further attempt, check if the fan is blocked and/or if air circulation is sufficient.
- In any event, have the appliance checked once a year by specialised personnel.
- Improper use of this hot air generator will cause injuries or risk of death by burns, fire, explosions, electrical shock or poisoning by carbon monoxide.
- Do not connect tubes to channel hot air.

## MAINS CONNECTION

Before connecting to mains, ensure that the voltage and frequency are correct. The mains connection has to be made according with the national norms in force.

Before carrying out any repair or maintenance operations, always disconnect the power supply cable.

## FUEL

In any event, only use gas in I<sub>3</sub>B/P categories.

## CONNECTION AND CHANGE OF THE GAS CYLINDER

Cylinder shall be changed in open air, far from heating sources or free flames.

In case of substitution of the gas hose, use only types listed in the components list or certified types for this particular use.

Connect the pipe to the generator input union, and then connect to the gas cylinder in the following order: pressure reducer (complete with safety valve) and gas hose.

Keep in mind that junctions have a left thread, secured by turning in an anti-clockwise direction. Make sure that the rubber ring is present between the reducer and the cylinder (should the type of connection require one). Check the tightness of the joints by pouring some liquid soap over: the presence of bubbles is evidence of gas leak. It is possible to connect a number of cylinders together for greater autonomy.

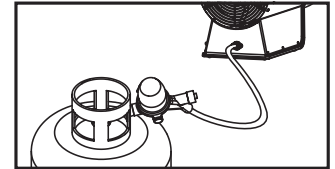
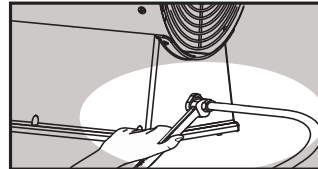

The supply pressure is provided by the pressure regulator supplied as a standard item, and corresponding to the technical specifications table.

Only the following accessories can be used to connect the cylinder:

- Flexible hose for liquid gas DK6.
- Liquid gas pressure regulator complete with safety valve.

## BURNER'S OPERATING CHECK

After ignition, burner operation can be inspected by looking at the flame at the hot air outlet. The flame should be completely and uniformly burning and does not lift or pull away from the thermocouple.

## IGNITION FOR MANUAL TYPES, ...KW M

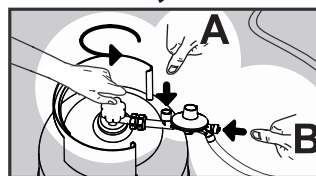

- 1.1. Turn on the cylinder.
- 1.2. Press the push-button to reset the safety valve.  
(A= 10-14-15 kW)  
(B= 25-30-53-73 kW)



2. Start the ventilator with the white switch.

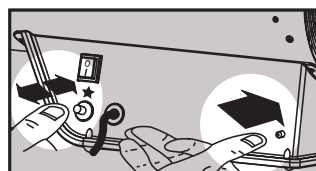

3. Press the gas button and, keeping it pressed, repeatedly press the electric piezo lighter.



4. After igniting the flame, keep the gas button pressed for 15 seconds to activate thermal safety devices.



5. At this point, release the button; the flame will remain lit.

6. Should the fan stop because of any power cut, the generator will automatically be turned off in a few seconds by the safety devices. In the event of gas interruption or low gas pressure, the gas safety valve will be automatically turned off at the heater. The fan will remain in operation. Repeat the "Ignition" procedure to re-ignite.

7. Avoid numerous attempts to ignite the apparatus in a short period: if it does not ignite immediately, investigate the source of the problem.

**N.B.:** Thermal power can be adjusted between a maximum and minimum level (see technical sheet) by means of a knob on the generator panel or an external regulator.

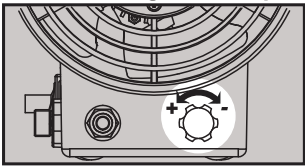

**15 kW M**

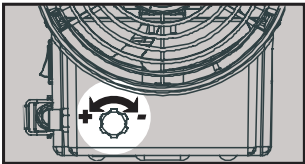

**30 kW M**  
**30 kW M DV**

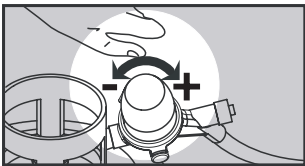

**53 kW M**  
**53 kW M DV**  
**73 kW M**  
**73 kW M DV**

## IGNITION FOR dual voltage MANUAL MODELS, ...kW DV

1. Check the position of the switch (220/240 -110). If it requires modifying, unscrew the 2 screws securing the cap and turn the switch to the voltage value being used.

2. Proceed as in the previous paragraph (ignition for manual ignition types, ...kW).

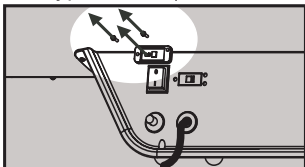

## STOPPING

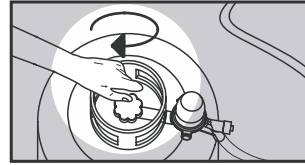

• Turn off the cylinder.

• Let the fan run for about 60 seconds for cooling.



• Turn the switch to position 0.

## USE IN ENVIRONMENTS WITH PERMANENT PRESENCE OF PEOPLE OR ANIMALS

• The generators can be used in well-ventilated rooms and when the percentage of polluting substances in the air does not exceed levels of danger for health.

• A good ventilation is guaranteed when the room's volume in m<sup>3</sup> is at least 30 times the nominal calorific power (in kW) of all the machines used in that room and when an air circulation through doors, windows or permanent openings can be guaranteed, whose size in m<sup>2</sup> is at least 0,003 times the nominal calorific power (in kW) of all the machines used in that room.

• The apparatus should not be used for continuous heating of stables and farms.

## USE IN ENVIRONMENTS WITH NO PERMANENT PRESENCE OF PEOPLE OR ANIMALS

• Signs must be displayed prohibiting people from stopping permanently in that room.

• The generators must only be used to dry rooms, provided that there is a guaranteed quantity of air exchange necessary for combustion.

• The necessary quantity of air is when the volume of the room in m<sup>3</sup> is at least 10 times the nominal calorific power (in kW) of all the machines used in that room.

• A normal air circulation through doors and windows must be assured.

## SUMMER VENTILATION

The heater can be used also like ventilator. Turn off the gas and disconnect the flexible gas hose from the gas cylinder. Connect the electrical plug to a suitable socket and set the switch in the position I.

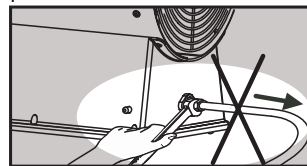

## CLEANING AND MAINTENANCE

Periodically and before putting the appliance away after use, clean it.

- Before starting any kind of maintenance and repairing operations, it is absolutely necessary to unplug the apparatus. To provide maintenance inside the compartment commands.
- Close the cylinder tap.
- Maintenance concerns solely cleaning the burner outlets, the eventual replacement of the calibrated nozzle and the replacement of the flexible hose.
- Clean the burner periodically if it is used in a dusty place.
- When the appliance is run by radio-control, check wear of the gas pipe and power cable; if you have any doubts about their condition, call in the servicing department.
- After each servicing operation a soundness test shall be carried out over the gas circuit by aid of soap water.

### 10 kW M - 14 kW M - 15 kW M - 25 kW M - 25 kW M DV - 30 kW M - 30 kW M DV

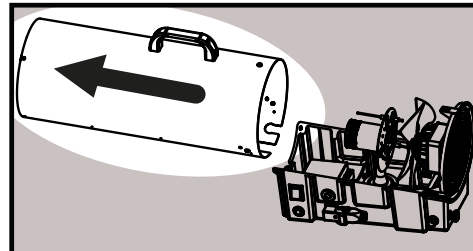
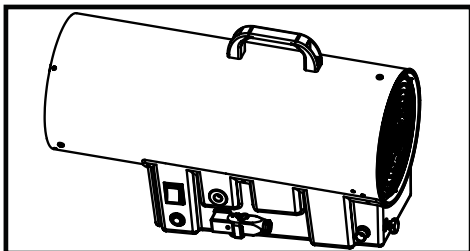

### 53 kW M - 53 kW M DV - 73 kW M - 73 kW M DV

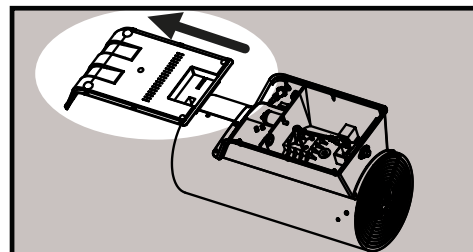
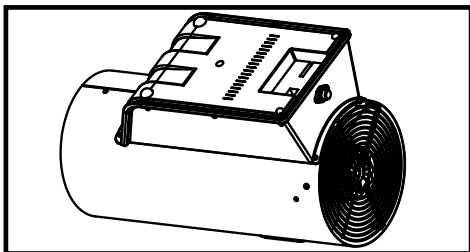

## TROUBLESHOOTING

PROBLEM	CAUSE	REMEDY
The motor does not turn on	<ol style="list-style-type: none"> <li>1. Faulty mains cable</li> <li>2. Faulty fan</li> <li>3. Faulty switch</li> </ol>	<ol style="list-style-type: none"> <li>1. Replace or repair</li> <li>2. Replace or repair</li> <li>3. Replace or repair</li> </ol>
The flame does not ignite	<ol style="list-style-type: none"> <li>1. Excessive distance between electrode and burner</li> <li>2. Lack of gas</li> <li>3. Faulty gas valve</li> <li>4. Safety valves tripped</li> </ol>	<ol style="list-style-type: none"> <li>1. Adjust distance</li> <li>2. Replace cylinder</li> <li>3. Specialized work needed</li> <li>4. Press the push-button to reset the safety valve (Fig.1-2-3)</li> </ol>
The flame goes out after a few seconds of ignition	<ol style="list-style-type: none"> <li>1. Excessive distance between the temperature sensor and the burner</li> <li>2. Gas button released after a too short time</li> <li>3. Faulty safety chain</li> <li>4. Appliance is overheated</li> </ol>	<ol style="list-style-type: none"> <li>1. Adjust distance</li> <li>2. Keep the button pressed a little longer (max 20")</li> <li>3. Specialized work needed</li> <li>4. Safety thermostat must cool. Wait 5 minutes and re-start</li> </ol>
Flame goes out during operation.	<ol style="list-style-type: none"> <li>1. Insufficient gas supplied</li> <li>2. Appliance overheating excessively</li> </ol>	<ol style="list-style-type: none"> <li>1. Replace the cylinder</li> <li>2. Insufficient air supplied</li> </ol>
The flame has a yellow luminous outline	<ol style="list-style-type: none"> <li>1. Air fault in the burner</li> <li>2. Excess of gas in the burner</li> </ol>	<ol style="list-style-type: none"> <li>1. Clean air inlet</li> <li>2. Adjust pressure and/or replace nozzle</li> </ol>